



HangZhou Ever-Power Transmission Co., LTD.

Add: ZiGui Plaza 28-2-302#268 WenErXi Road,
HangZhou, Zhejiang, China

Tel: 0086-571-88220039/88220019/88220973

Fax: 0086-571-56287761/88220972

E-mail: gan@china-reducers.com
hq@hzpt.com

Web: <http://www.china-reducers.com>

Ver: EP series 2006

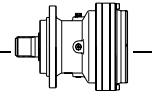

This catalogue presents **Hangzhou Ever-Power Transmission Co., Ltd.**'s range of Series **EP** modular planetary gearboxes.

The use of planetary gear units in the field of power transmission is the modern answer to the demand for compactness constructive simplicity, high product reliability and efficiency.

Products of the company are as follows:

- 1, EP300 series planetary drives.
- 2, EP400 series wheel drives.
- 3, EP600 series track drives.
- 4, EP700 series slewing drives



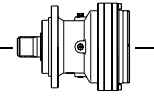
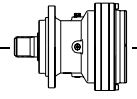

Table of contents

Description	Page
Symbols, units of measure and description	4 - 4
Technical characteristics and general information	5 - 13
EP300 Series planetary drives	14 - 27
1.0 Introduction	15 - 15
2.0 Construction versions	15 - 17
3.0 Mounting position	18 - 19
4.0 Lubrication	20 - 20
5.0 Plug positions	21 - 22
6.0 Reference oil quantity	23 - 23
7.0 Negative multi disc brake	24 - 24
8.0 Product identification scheme	25 - 27
EP300 series gear motor	28 - 79
P1=0.12KW, 0.18KW, 0.25KW n1=1400 min ⁻¹	28 - 30
P1=0.37KW n1=1400 min ⁻¹	31 - 32
P1=0.55KW n1=1400 min ⁻¹	32 - 34
P1=0.75KW n1=1400 min ⁻¹	34 - 36
P1=1.1KW n1=1400 min ⁻¹	36 - 38
P1=1.5KW n1=1400 min ⁻¹	38 - 41
P1=2.2KW n1=1400 min ⁻¹	41 - 44
P1=3.0KW n1=1400 min ⁻¹	44 - 47
P1=4.0KW n1=1400 min ⁻¹	47 - 51
P1=5.5KW n1=1400 min ⁻¹	51 - 55
P1=7.5KW n1=1400 min ⁻¹	55 - 59
P1=11KW n1=1400 min ⁻¹	59 - 64
P1=15KW n1=1400 min ⁻¹	64 - 68
P1=18.5KW n1=1400 min ⁻¹	68 - 71
P1=22KW n1=1400 min ⁻¹	71 - 74
P1=30KW n1=1400 min ⁻¹	74 - 76
P1=37KW n1=1400 min ⁻¹	76 - 77
P1=45KW, 55KW, 75KW, 90KW n1=1400 min ⁻¹	78 - 79
EP300 series gearbox (parameter and dimension)	80 - 199
EP300 gearbox (parameter and dimension), M ₂ '=1000 N.m	80 - 89
EP301 gearbox (parameter and dimension), M ₂ '=2000 N.m	90 - 99
EP303 gearbox (parameter and dimension), M ₂ '=3000 N.m	100 - 109
EP305 gearbox (parameter and dimension), M ₂ '=5000 N.m	110 - 119
EP306 gearbox (parameter and dimension), M ₂ '=8500 N.m	120 - 129
EP307 gearbox (parameter and dimension), M ₂ '=12500 N.m	130 - 139
EP309 gearbox (parameter and dimension), M ₂ '=18500 N.m	140 - 149
EP310 gearbox (parameter and dimension), M ₂ '=25000 N.m	150 - 159
EP311 gearbox (parameter and dimension), M ₂ '=35000 N.m	160 - 169
EP313 gearbox (parameter and dimension), M ₂ '=50000 N.m	170 - 179
EP315 gearbox (parameter and dimension), M ₂ '=80000 N.m	180 - 189
EP316 gearbox (parameter and dimension), M ₂ '=105000 N.m	190 - 199
EP400 series track drives (parameter and dimension)	200 - 202
EP600 series wheel drives (parameter and dimension)	203 - 205
EP700 series slewing drives (parameter and dimension)	206 - 208



Symbols, units of measure and description

Symbol	Unit	Description
A_{C1}	(N)	Calculated thrust load at gearbox input shaft
A_{C2}	(N)	Calculated thrust load at gearbox output shaft
A_{n1}	(N)	Rated thrust load at gearbox input shaft
A_{n2}	(N)	Rated thrust load at gearbox output shaft
F_h		Lifetime factor for gearbox calculation
F_{h1}, F_{h2}		Lifetime factor for bearing shafts calculation
f_{h1}, f_{h2}		Load corrective factor on shafts
f_m		Increase factor
f_s		Service factor
f_t		Thermal factor
f_{tp}		Temperature factor
f_v		Speed factor
h	(h)	Lifetime in hours
i		Gearbox ratio
M_2'	(N.m)	Reference torque
M_2	(N.m)	Torque delivered to output shaft
M_b	(N.m)	Rated brake torque
M_{c2}	(N.m)	Calculated torque at gearbox output
M_{n2}	(N.m)	Gearbox rated output torque
M_{n2}'	(N.m)	Gearbox rated output torque, life time=10000 hours
M_{2max}	(N.m)	Gearbox max. output torque
M_{r1}	(N.m)	Require torque at gearbox input
M_{r2}	(N.m)	Require torque at gearbox output
n_1, n_2	(min^{-1})	Angular speed at gearbox input, Angular speed at gearbox output
P	(bar)	Hydraulic oil pressure
P_1	(KW)	Max. transmissible power at gearbox input
P_1'	(KW)	Transmissible power at gearbox input
P_2	(KW)	Transmissible power at gearbox output
P_n	(KW)	Gearbox rated power
P_{r1}	(KW)	Required input power
P_{r2}	(KW)	Output power at n_2 max.
P_{r2}'	(KW)	Output power at n_2 min.
P_s	(KW)	Excess power
P_t	(KW)	Gearbox thermal capacity
Q	(L/min)	Hydraulic flow rate
R_{c1}, R_{c2}	(N)	Calculated radial load of gearbox input shaft, Calculated radial load of gearbox output shaft
R_{x1}	(N)	Rated radial load at gearbox input re-calculated with respect to different load application points
R_{x2}	(N)	Rated radial load at gearbox output re-calculated with respect to different load application points
S		Safety factor
t_a	($^{\circ}\text{C}$)	Ambient temperature
V	cm^3	Hydraulic motor displacement
V_c	cm^3	Theoretical hydraulic motor displacement
X	mm	Load application distance from shaft shoulder
η_d		Dynamic efficiency

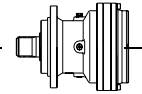

TECHNICAL CHARACTERISTICS AND GENERAL INFORMATION

1. OUTPUT TORQUE

1.1 Reference torque M_2' (N.m)

Indicative output torque to easily establish the performance class for each gearbox basic size.

1.2 Gear motor delivered torque M_2 (N.m)

This is the net torque delivered to the output shaft, with installed power P_n , safety factor S , which will yield a theoretical lifetime of 10000 hours. This torque value takes gearbox efficiency into consideration.

1.3 Nominal torque M_{n2} (N.m)

Torque transmission at output at uniform continuous load, service factor $f_s=1$ for different fixed values of the life factor ($n_2 \times h$).

1.4 Rated output torque M_{n2}' (N.m)

This is the torque output the gearbox can deliver safely, based on: uniform loading and safety factor $S=1$, 10000 hours theoretical lifetime.

1.5 Max. torque M_{2max} (N.m)

It is the output torque that the reduction unit can withstand in static or highly intermittent conditions. (It is considered as instantaneous load peak torque or starting torque under load).

1.6 Required torque M_{r2} (N.m)

This is the torque corresponding to application requirements. It must always be equal or less than rated output torque M_{n2} of the selected gearbox.

1.7 Calculated torque M_{c2} (N.m)

Torque value to be used for selecting the gearbox, considering required torque M_{r2} and service factor f_s (table 3), and is obtained by formula:

$$M_{c2} = M_{r2} \times f_s < M_{n2} \quad (F1)$$

Where M_{n2} is the value for the specific application taking into consideration the life factor ($n_2 \times h$)

2. POWER

2.1 Input rated power P_1 (KW)

Power P_1 indicated in the specification table for each gearbox size is either the intermittent or continuous power which can be transmitted at the gearbox input under the following conditions:

Input speed	n_1
Theoretical duration	1000 h
Service factor	$f_s=1$

Check that the formula here below is always satisfied:

$$P_1' \times f_s < P_1 \quad (F2)$$

2.2 Output power P_2 (KW)

This value is the power transmitted at gearbox output. It can be calculated with the following formulas:

$$P_2 = P_1 \times \eta_d \quad (F3)$$

$$P_2 = (M_{r2} \times n_2) / 9549 \quad (F4)$$

3. THERMAL POWER P_t (KW)

This value indicates the gearbox's thermal capacity (refer to the technical data concerning the gearboxes under consideration) and is the power that can be transmitted under continuous duty, at an input speed n_1 of 1500 min^{-1} at an ambient temperature of 20°C without using a supplementary cooling device.

For a duty cycle with short operating periods and sufficiently long pauses to allow the unit to cool, thermal power is not particularly important and therefore it does not need to be taken into consideration.

At an ambient temperature other than 20°C under intermittent duty conditions and with an input speed n_1 other than 1500 min^{-1} it is possible to calculate the P_t value according to the thermal factor f_t and the speed factor f_v , shown in table (1).

Make sure that the following condition is always satisfied: $P_{r1} \leq P_t \times f_t \times f_v \quad (F5)$

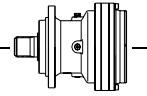

Table: 1

ta max. (°C)	ft					n1	fv
	Continuous duty	Intermittent duty					
		Cyclic duration factor % (l)					
		% (l) = $t_f / (t_f + t_r) \times 100\%$ (t_f : operating time under load) (t_r : rest time)					
100%	80%	60%	40%	20%			
10	1.2	1.3	1.6	1.8	2.0	500	1.7
20	1	1.1	1.3	1.5	1.7	750	1.5
30	0.9	1	1.2	1.3	1.5	950	1.2
40	0.7	0.8	0.9	1	1.2	1500	1
50	0.5	0.6	0.7	0.8	0.9	1750	0.85
						2000	0.7
						2500	0.5
						3000	0.4

4. DYNAMIC EFFICIENCY η_d

Obtained from the ratio of output power P_2 to input power P_1 according to the following equation:

$$\eta_d = P_2 / P_1 \quad (F6)$$

Its value is a function of the transmitted power, the speed, the reduction ratio and oil temperature and viscosity. The maximum efficiency values are shown in the table (2) below.

Table 2:

N° stage			
L1	L2, R2	L3, R3	L4, R4
0.97	0.94	0.91	0.88

5. REDUCTION RATIO i

This is the ratio of gearbox input speed to gearbox output speed.

$$i = n_1 / n_2 \quad (F7)$$

6. ANGULAR SPEED

6.1 Input speed n_1 (min^{-1})

Refers to the speed of motor if motor is directly connected to gearbox. In the case of an indirect drive, this value is the speed of the motor divided by the transmission ratio of the indirect drive accessory (belt, chain, etc.).

Input speed should exceed the values indicated in the tables on gearbox technical features.

As for continuous operation in industrial applications, we recommend that speed of 1750 min^{-1} be never exceeded.

6.2 Output speed n_2 (min^{-1})

Calculated from input speed n_1 and transmission ratio i according to the following equation:

$$n_2 = n_1 / i \quad (F8)$$

7. SERVICE FACTOR f_s

Factor depending on the application type. This factor takes into consideration (with sufficient approximation) load variations which the gearbox may undergo for a specific type of duty. It also takes into consideration the selected type of the drive unit, electric or hydraulic motor and so on.

Table (3) gives indications for the service factor to be selected according to the application and operation type.

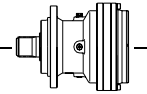

Table 3:

		SERVICE FACTOR f_s				
		Number of starts (/hour)				
Type of load	Type of drive unit	16	32	63	125	250
Uniform load	Electric motor	1.00	1.10	1.15	1.25	1.4
	Hydraulic motor	1.00	1.00	1.10	1.15	1.20
	Endothermic engine	1.25	--	--	--	--
Moderate shock load	Electric motor	1.10	1.15	1.20	1.40	1.60
	Hydraulic motor	1.00	1.00	1.10	1.20	1.30
	Endothermic engine	1.50	--	--	--	--
Heavy shock load	Electric motor	1.20	1.30	1.40	1.60	1.80
	Hydraulic motor	1.10	1.20	1.25	1.35	1.50
	Endothermic engine	2.00	--	--	--	--

8. SAFETY FACTOR S

This is the relationship of the gear unit rated power to the power of the electric motor actually driving the unit

$$S = P_{n1} / P_1 \quad (F9)$$

9. LIFE FACTOR F_{h1}, F_{h2}

Factor resulting by multiplying angular speed at input (n_1) or output (n_2) by actual operating working hours h, break time excluded.

$$F_{h1} = (n_1 \times h) \quad (F10)$$

$$F_{h2} = (n_2 \times h) \quad (F11)$$

Life factor is directly proportional to gearbox rpms during the whole duty time.

10. SELECTION

Some essential data are necessary for a proper gearbox of gear motor selection as indicated in table (4).

Fill in the table and send a copy to our technical service department which will select the most suitable gearbox for your application requirements.

11. GEARBOX SELECTION

a) Determine the following according to the required application:

- Service factor f_s (Table 3)
- Required gearbox working life (h)
- Required drive unit (hydraulic, electric or others)

b) Define the calculated torque with the required output torque M_{c2}

$$M_{c2} = M_{r2} \times f_s \quad (F12)$$

c) Calculate the life factor with required working life h and output speed n_2 :

$$F_{h2} = (n_2 \times h) \quad (F13)$$

d) Calculate the required reduction ratio:

$$i = n_1 / n_2 \quad (F14)$$

e) Select gearbox size which, having a reduction ratio close to the calculated value, and see the following:

$$M_{c2} \leq M_{n2} \quad (F15)$$

$$F_{h2} \leq (n_2 \times h) \quad (F16)$$

Where M_{n2} and F_{h2} are indicated in the tables on technical features for each gearbox size.

In case of applications in which the required M_{r2} and speed n_2 vary within a wide range, best

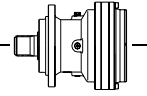

selection could be an equivalent required torque given by:

$$M_{r2} = \{[(n2 \times h)_A \times M_A^4 + (n2 \times h)_B \times M_B^4 + (n2 \times h)_C \times M_C^4 + \dots] / [(n2 \times h)_A + (n2 \times h)_B + (n2 \times h)_C + \dots]\}^{0.25}$$

Referred to:

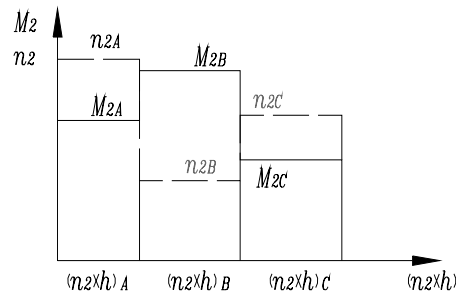

And calculating the life factor F_h with:

$$F_{h \text{ calc}} = (n2 \times h)_A + (n2 \times h)_B + (n2 \times h)_C \quad (F17)$$

Then follow the same procedure as specified in d) and e).

Table (4): **DATA SHEET FOR SELECTING REDUCTION GEAR**

Data application sheet for selecting reduction gear	
Name of client:	Address: Date:
Application description:	
Type of motor and drive unit: Electric /Hydraulic /Others	
Gearbox	
P_{r2}	Required output power: (Kw) IEC or NEMA size:
M_{r2}	Required output torque: (N.m) Rated power: (KW)
n_2	Output speed: (min^{-1}) Motor voltage: (V)
n_1	Input speed: (min^{-1}) Number of poles:
R_{c2}	Radial load on output shaft: (N) Frequency: (Hz)
X_2	Load application distance: (mm) Duty type to IEC norms: s / %
R_{c1}	Radial load on input shaft: (N) Starting frequency: 1/h
X_1	Load application distance: (mm) Motor protection degree: IP
A_{c2}	Thrust load on output shaft: (N) Insulation class:
A_{c1}	Thrust load on input shaft: (N) Brake in self-braking motor:
h	Required life lifetime: (h) Brake voltage: (V) Brake torque Mb: (N.m)
ta	Ambient temperature: ($^{\circ}\text{C}$) HYDRAULIC MOTOR
Type: Linear Right angle	Brand:
Output version:	Type:
Accessories:	Min./Max. displacement: (cm^3)
Mounting position:	Max. operating pressure: (bar)
Lubricants: mineral /synthetic	Max. operating flow rate: (l/min^{-1})
	Hydraulic brake: yes /no
	Brake torque Mb: (N.m)

NOTE:

The selection criteria and specifications reported in this catalogue are not valid for any applications, including those where the gearbox is to serve as a safety device preventing injury to people or damage to objects, as is the case with hoisting equipment.

For these applications, however, the accordance with any safety rules in force. For this reason, we recommend that you seek advice from Ever-power transmission co., ltd.

12. VERIFICATION

After selecting the drives units, please check the following:

a) Thermal power

Make sure that thermal power of the gearbox (shown in the tables in the chapters dealing with the gear unit series captioned) is equal to or greater than the power required by the application according to equation (F5) on page 5. If this condition is not reached, select larger gearbox or apply a forced cooling system.

Example of oil re-circulation cooling system:

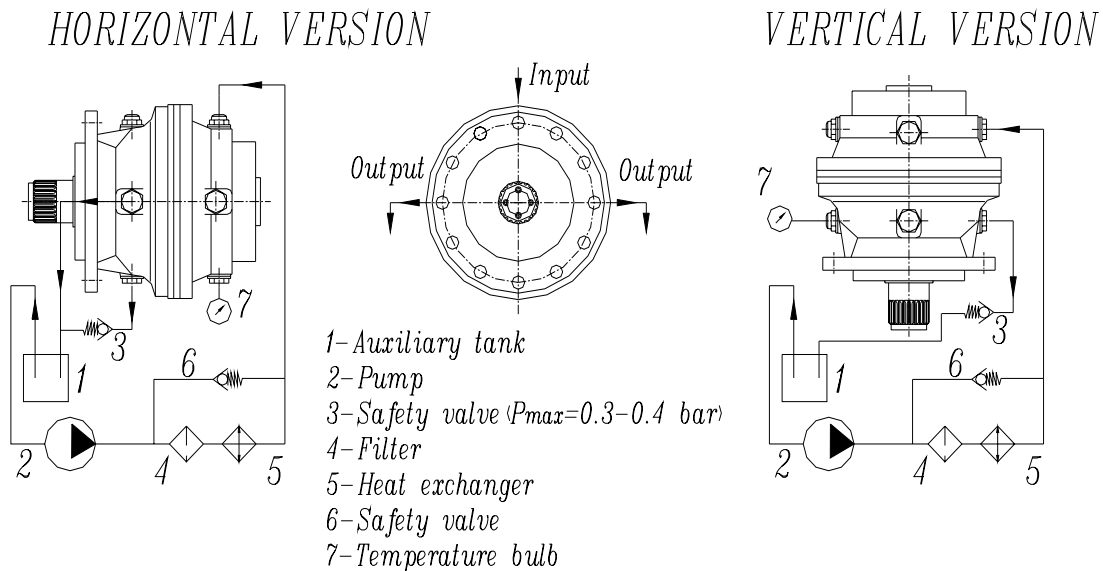

b) Maximum torque

Make sure that the maximum torque (considered as instantaneous load peak torque or starting torque under load) does not exceed the M_{2max} value that the gearbox can withstand. (Refer to the technical data tables concerning the gearboxes sizes.)

c) Radial loads

Check that radial loads exerted on input and output shafts are lower than or equal to values indicated in the tables on gearbox technical features or charts for each gearbox size. In case they are greater than the indicated value, change either gearbox output version, gearbox size or system bearing arrangement.

To check proceed as follows:

Define radial loads Rc_1 at input and Rc_2 at output.

$$Rc_1 = 2000 \times Mc_1 \times Kr_1 / d_1 \quad (F18)$$

$$Rc_2 = 2000 \times Mc_2 \times Kr_2 / d_2 \quad (F19)$$

In which:

Mc_1, Mc_2 ----- Input and output calculated torque (N.m)

d_1, d_2 ----- Diameter of the part fitted onto the shaft (mm), pulley, gear or chain crown.

Kr_1, Kr_2 ----- Stress factor for radial load with following values

Chain crown ----- 1.0

Gear ----- 1.25

Belt pulley ----- 1.5-2.5

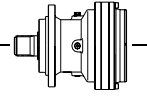

Define the thrust load position X onto shaft. Check this value with the chart indicating the load R_{x1} and R_{x2} bearable by the gearbox. Check that the following is satisfied:

$$RC_1 \leq R_{x1} \times f_{h1} \quad (F20)$$

$$RC_2 \leq R_{x2} \times f_{h2} \quad (F21)$$

Where f_{h1} and f_{h2} the radial and thrust load corrective factor depending on the required life factor F_{h1} and F_{h2} .

d) Thrust loads

check the thrust load, when exerted onto the output shaft, as specified for the radial load. The following should be satisfied:

$$\pm A_{c2} \leq \pm A_{n2} \times f_{h2} \quad (F22)$$

when a thrust load is combined with an axial load contact HZPT sales department.

13. HOW TO SELECT THE MOTOR

Electric motor

a) n_2 and dynamic efficiency η_d are known, calculate input power based on torque M_{r2} as follows:

$$P_{r1} = (M_{r2} \times n_2) / (9549 \times \eta_d) \quad \text{KW} \quad (F23)$$

Table (2) on page 6 reports the values of efficiency η_d related to the different reduction stages of the gearboxes.

b) Look up the motor selection charts and select a size with such rated power to satisfy this condition:

$$P_{r1} \leq P_n \quad (F24)$$

4-pole motor and over should be preferred.

Unless otherwise specified, power P_n of motors indicated in the catalogue refers to continuous duty S1.

For motors used in conditions other than S1, the type of duty required by reference to CEI 2-3/IEC 34-1 Standards must be mentioned.

For duties from S2 to S8 in particular and for motor frame 132 or smaller, extra power can be obtained with respect to continuous duty power, consequently the following condition must be satisfied:

$$P_{r1}/f_m \leq P_n \quad (F25)$$

The increased power factor f_m can be obtained from table (5).

Table 5:

fm	Duty						
	S2			S3*			S4-S8
	Cycle duration (min ⁻¹)			Cyclic duration factor % (I) % (I) = $t_f / (t_f + t_r) \times 100\%$ (t_f : operating time under load) (t_r : rest time)			
	10	30	60	25%	40%	60%	Please contact us
	1.35	1.15	60	1.25	1.15	1.1	

***Cycle duration, in any event, must be 10 minutes or less. If it is longer, please contact Ever-power transmission co., ltd. technical service department.**

For duties other than S1 with considerable number of starts per hour, factor Z must be considered (it is ascertained by using the information in the motors chapter). Factor Z defines the maximum number of starts for the application under consideration.

c) For the output speed n_2 or closest to, select the gear motor that yields a safety factor S meeting the following condition: $S \geq f_s$ (F26)

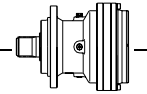

Hydraulic motor

Determine hydraulic motor type according the application, choosing from the options given in guidance table (6).

Table 6:

Duty	Light		Medium		Heavy	
Pressure (bar)	<175		175-200		200-450	
Motor design	Orbital	Gear motor	Radial piston	Axial piston	Cam motor	Axial piston
Speed (rpm)	Mean <=700	High <=3000	Mean <=500	High <=4000	Low <=200	Mean <=4000
η_{mh}	0.80	0.85	0.95	0.93	0.93	0.93
η_v	0.90	0.87	0.95	0.95	0.95	0.95

Based on the specifications of gearbox input:

Input torque ----- M_{r1} (N.m)

Input speed----- n_1 (min^{-1})

And on allowed pressure P (bar) for the hydraulic circuit, calculate the displacement of the hydraulic motor by formula:

$$V_c = (20 \times \pi \times M_{r1}) / (P \times \eta_{mh}) \quad \text{cm}^3 \quad (\text{F27})$$

Where η_{mh} is the hydraulic mechanical efficiency of the motor (Table 6).

Select a motor size with displacement V that satisfies the following condition:

$$V_c \leq V \quad (\text{F28})$$

Calculate the flow required for the hydraulic motor

$$Q_1 = (V \times n_1) / \eta_v \times 1000 \quad (\text{l/min}^{-1}) \quad (\text{F29})$$

Where η_v is the volumetric efficiency of the motor (Table 6).

14. INSTALLATION

Observing a few rules for correct installation is essential to the reliable and proper operation of the gearbox or gear motor.

The rules set out here are intended as a preliminary guide to select gearbox or gear motor. For effective and proper installation, follow the instructions given in the installation, use the maintenances manual for the gearbox available from our sales department.

Following is a brief outline of installation rules:

a) Fastening:

Place gearbox on a surface providing adequate rigidity. Mating surfaces should be machined and flat.

Mating surfaces must be within definite geometric tolerances (see manual). This is especially true of flange-mounted gearboxes with splined hollow shafts.

In applications that involve high radial loads at the output end, flange mounting is recommended for some gearbox sizes as this mounting makes use of the double pilot diameters provided in these gearboxes.

Make sure the gearbox is suitable for the required mounting position.

Use screws of resistance class 8.8 and over to secure the gearbox. Torque up screws to the figures indicated in the relevant tables.

With transmitted output torque greater than or equal to 70% of the indicated $M_{2\max}$ torque, and with frequent movement reversals, use screws with minimum resistance 10.9.

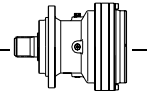

Some gearbox sizes can be fastened using either screws or pins. pin seated in the frame of the gearboxes be at least 1.5 times pin diameter.

b) Connections

Secure the connection parts to gearbox input and output. Do not tap them with hammers or similar tools. To insert these parts, use the service screws and threaded holes provided on the shafts. Be sure to clean off any grease or protect from the shafts before fitting any connection parts.

Fitting hydraulic motors.

Be careful the O ring between motor flange and gearbox input flange when assembling. Install the hydraulic motor before filling lube oil into the gearbox.

Connecting the hydraulic brake.

The hydraulic circuit should be such to ensure that brake is released instantly before gearbox starts and applied after gearbox has stopped. Check that pressure in the hydraulic line for brake release is at zero whenever gearbox is stopped.

Direction of rotation

Motors are connected to the suitable electric or hydraulic circuit according to their direction of rotation. When performing these connections, bear in mind that all gearboxes, whether in the in-line or right angle design, have the same direction of rotation both at input and output. For more details of the connection of electric and hydraulic motors, see relevant sections in this catalogue.

c) Painting

Painted with antioxidant water primer in the colour red. Mating surfaces are not painted. Final coat is to be applied by the customer. Before painting, protect the seal rings installed on the shafts. Contact with paint may deteriorate the seals with subsequent oil leakage.

d) Lubrication

Before start-up, fill the gearbox with the recommended lube oil up to correct level. Level is checked through the suitable plug or sight glass provided on each gearbox depending on designated mounting position

15. MAINTENANCE

Gearboxes are virtually maintenance free under normal operating conditions. The only periodic operations required are checks on oil level and oil changes as follows:

Oil Changes

Change the oil first after 100-150 hours operation.

Subsequently, change the oil only every 2000-3000 hours operation depending on application.

Alternatively change oil once a year.

Check the oil level in the gearbox every month and top up as necessary .

16. STORAGE

Observe the following instructions to ensure correct storage of delivered products:

- a) Do not store outdoors, in areas exposed to weather or with excessive humidity;
- b) Always place boards in wood or other material between floor and products, to avoid direct contact with the floor;
- c) For storage periods of over 60 days, all machines surfaces such as flanges, shafts and coupling must be protected with a suitable anti oxidation product(SHELL ENSIS FLUID SDC or equivalent product);
- d) The following measures must be taken in respect of products for which the expected storage period

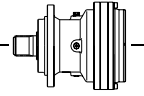

exceeds 6 months:

- d1) Cover outer machined parts and mating parts with grease to avoid oxidation;
- d2) Position the gearboxes with the breather plug up and fill them with oil (this does not apply to life-lubed gearboxes). Before use, the gearboxes should be filled with the proper amount lubricant of the recommended type

17. SUPPLY CONDITIONS

Gearboxes are supplied as follows:

- a) ready for installation in the mounting position specified on order;
- b) dry inner parts are protected by a film of the oil used for final testing;
- c) painted with antioxidant water primer in the color red, Mating surfaces are not painted and are covered with a film or protective oil. Final coat is to be applied by the Customer;
- d) tested to in-house specifications;
- e) suitably packed;
- f) complete with mounting nuts and bolts for IEC electric motors;

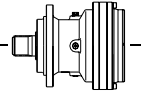

EP300 SERIES PLANETARY DRIVES

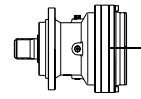

1.0 INTRODUCTION

The EP300 series consist of a range of multi-purpose planetary gearboxes that can be operated by either hydraulic or electric motors. Basic features are:

- 12 sizes
- output torque up to 160 000 N. m
- transmissible power up to 250 KW
- ratios from 3.5:1 to 3 000:1
- versions: in-line and right angle (first stage with bevel gear pair Gleason)
- reduction stages ranging from 1 to 4
- with flange-mounted, foot-mounted and shaft-mounted output
- output shafts with keyway, splined, splined hollow shafts, hollow shafts for shaft-mounting with shrink disc
- input adaptors for: electric motors to IEC standards design B5 or NEMA standard, hydraulic motors by major manufactures and according to SAE J744C, negative hydraulic parking brakes for operation by hydraulic motors
- output shaft accessories: flanges, pinions , splined bars, shrink discs
- high radial and axial load capacity of output shaft s thanks to tapered roller bearings fitted on the HZ and PC versions
- high efficiency
- housing made of spheroidal cast iron .

2.0 CONSTRUCTION VERSIONS

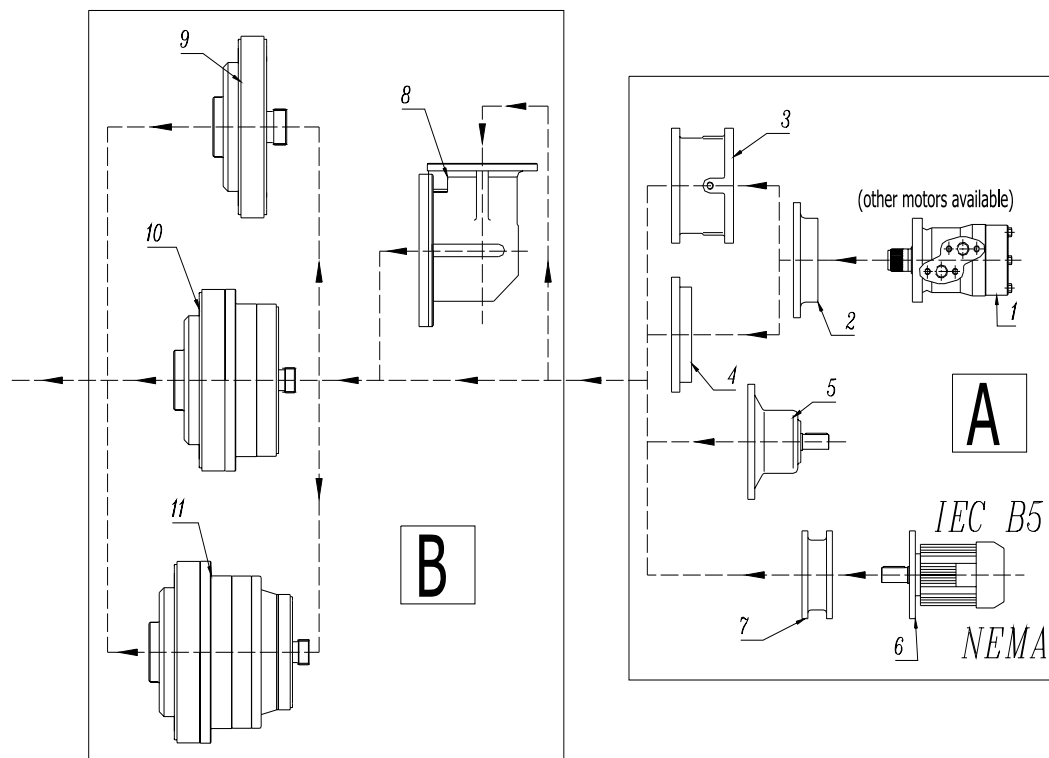

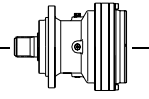

2.0 CONSTRUCTION VERSIONS

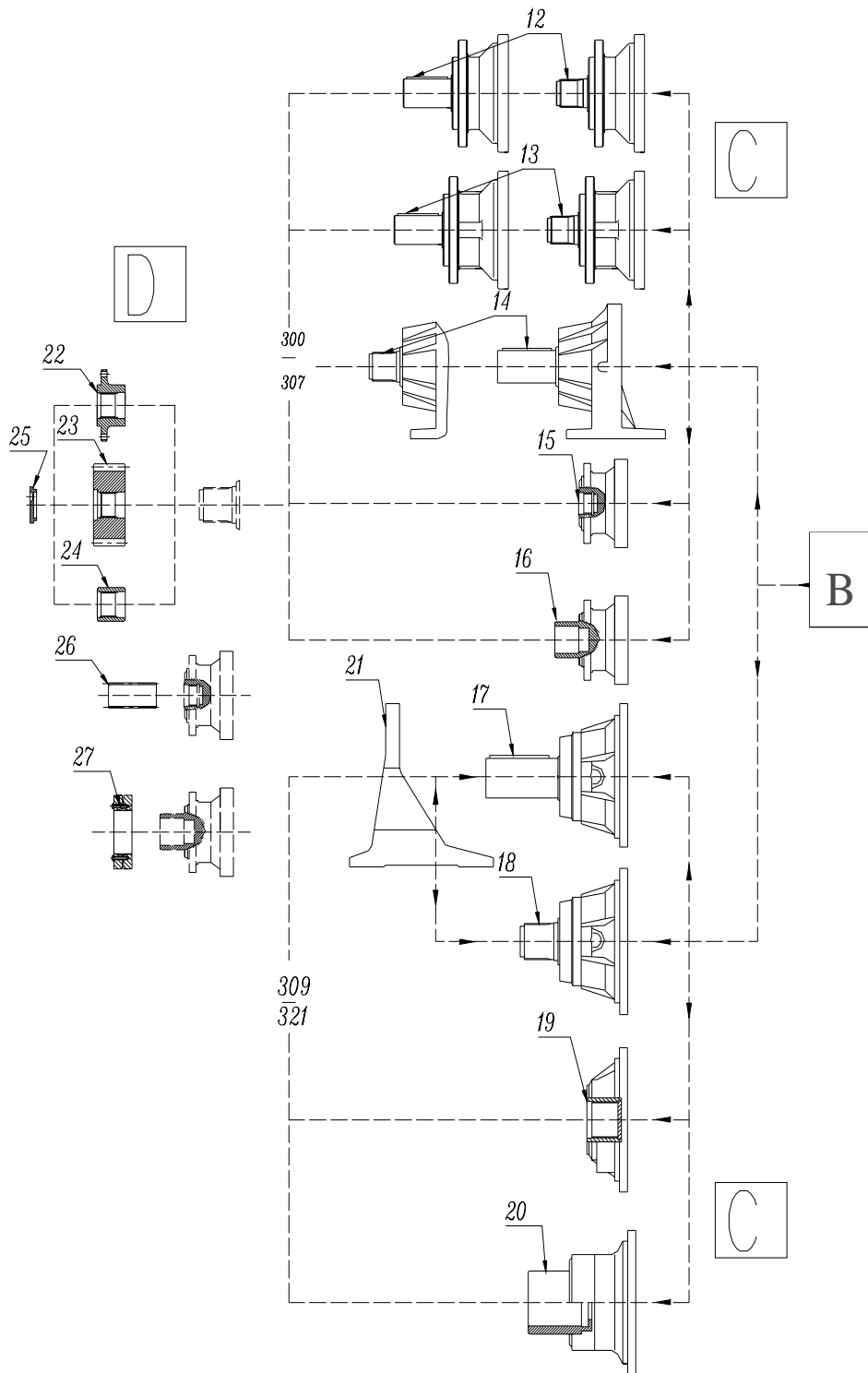

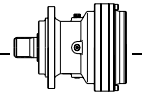

A: INPUT

1. Hydraulic motor
2. Hydraulic motor setting
3. Negative brake
4. Cover
5. Input shaft
6. Electric motor
7. Electric motor setting

B: REDUCTIONS

8. Right-angle reduction stage
9. Single planetary reduction stage
10. Two or more planetary reduction stages
11. Three or more planetary reduction stages

C: OUTPUT

12. Keyed or splined solid shaft output
13. Keyed or splined heavy solid shaft output
14. Output with support bracket and keyed or splined solid shaft
15. Splined hollow shaft output
16. Hollow shaft output for shrink disc
17. Keyed solid shaft output
18. Splined solid shaft output
19. Splined hollow shaft output
20. Hollow shaft output for shrink disc
21. Support bracket

D: FITTINGS

22. Flange
23. Pinion
24. Sleeve coupling
25. Stop bottom plate
26. Splined bar
27. Shrink disc

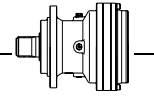

3.0 MOUNTING POSITION

For a proper designation of the geared motor or gearbox, mounting position please refer to the table (7) to determine mounting position.

Table 7: (in - line)

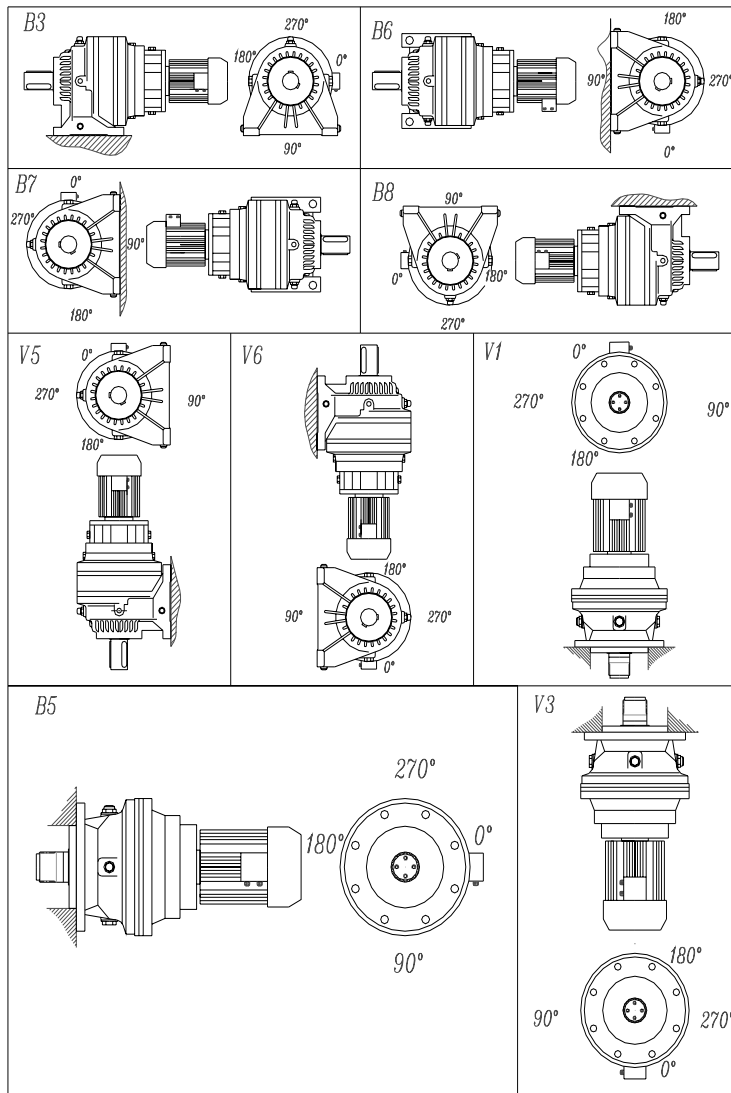

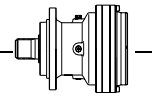
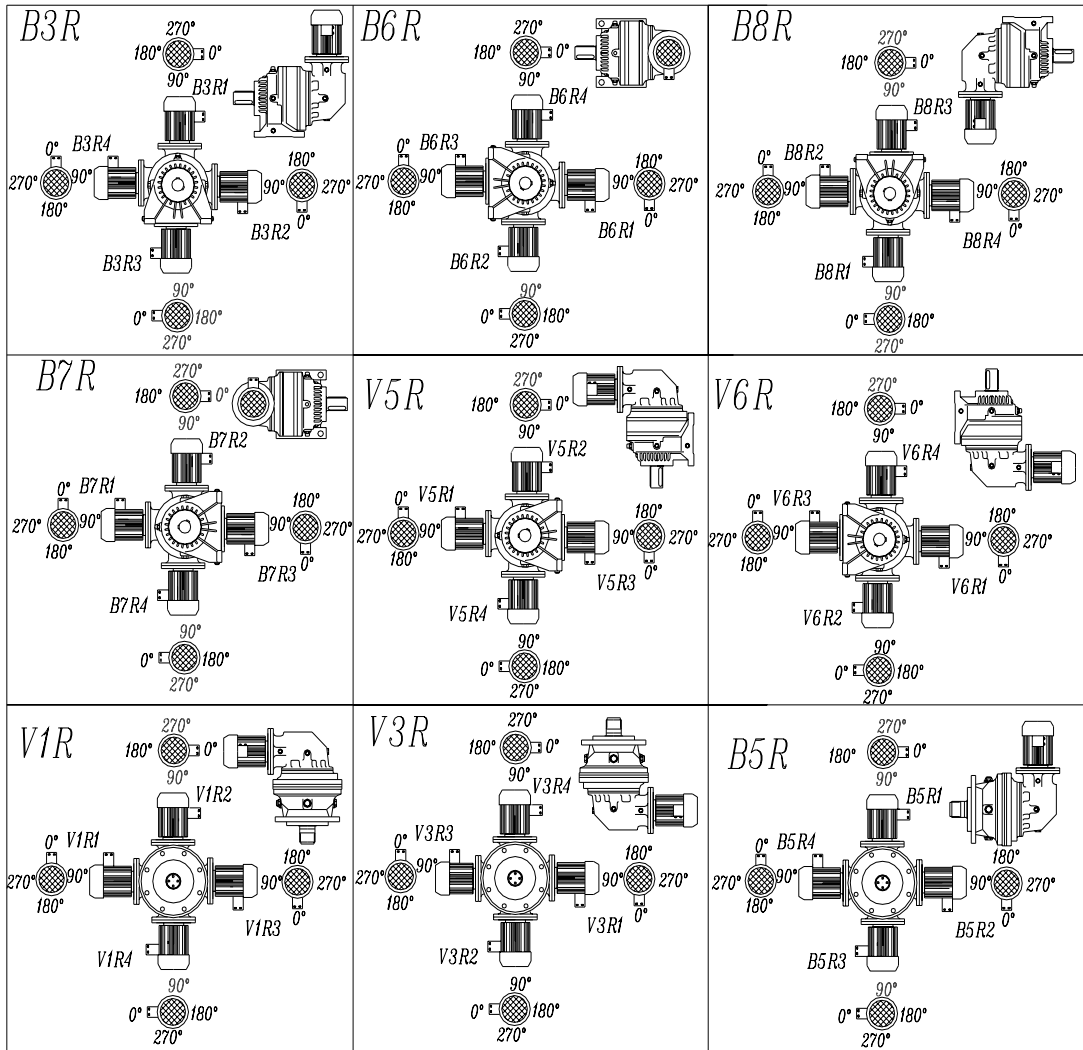
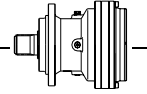

Table 7: (right angle)





4.0 LUBRICATION

(Prior to start-up)

Standard lubrication is oil bath. Respect the specifications given below for fixed and mobile machines:

- 1) Mobile machinery: SAE 80W/90 oil with API GL5 properties
- 2) Industrial machinery: ISO VG 150 oils with E.P. properties

The following table lists the most common brands of lubricant and the types recommended for normal applications.

Table 8:

	INDUSTRIAL PLANTS INDUSTRIEANGEN		MOBILE MACHINES	
	ISO standard...E.P. grade		SAE standard...APL GL grade	
Ambient	-10° C/+30° C	+20° C/+45° C	-10° C/+30° C	+20° C/+45° C
	ISO VG 150	ISO VG 220	SAE 80W/90	SAE 85W/140
AGIP	BLASIA 150	BLASIA 220	ROTRA MP	ROTRA MP
ARAL	DEGOL BG 150	DEGOL BG 220	GETRIEBEOL HYP	GETRIEBEOL HYP
BP - MACH	ENERGOL GR XP 150	ENERGOL GR XP 220	HYPOGEAR EP	HYPOGEAR EP
CASTROL	ALPHA SP 150	ALPHA SP 220	HYPOY	HYPOY
CHEVRON	EDWNL. GEAR COMPOUND 150	N.L. GEAR COMPOUND 220	UNIVERSAL GEAR	UNIVERSAL GEAR
ELF	REDUCTELF SP 150	REDUCTELF SP 220	TRANSELF8	TRANSELF8
ESSO	SPARTAN EP 150	SPARTAN EP 220	GEAR OIL GX	GEAR OIL GX
FINA	GIRAN 150	GIRAN 220		
I.P.	MELLANA 150	MELLANA 220	PONTIAX HD	PONTIAX HD
KLÜBER	LAMORA 150	LAMORA 220		
MOBIL	MOBIL GEAR 629	MOBIL GEAR 630	MOBILUBE HD	MOBILUBE HD
SHELL	OMALA EP 150	OMALA EP 220	SPIRAX HD	SPIRAX HD
TOTAL	CARTER EP 150	CARTER EP 220	TRANSMISSION TM	TRANSMISSION TM

Note:

1, For particular applications like: high temperature running conditions, non inflammable oil, etc.

contact HZPT technical Departments.

2, Maximum operating oil temperature must never exceed 85° C.

BRAKES LUBRICATION

The hydraulically operated multi disc brakes are lubricated by the same oil as the gearbox.

FILLING

Gearboxes are supplied without oil. All gearboxes are equipped with filler, lever, breather, and drain plugs. To fill the gearbox secure it in its exact working position, unscrew the oil filler plug, and add oil until it is visible in the level window. The position of the window will obviously depend on whether the unit is mounted horizontally or vertically. To drain, remove the magnetic drain plug and drain off oil. If possible, drain while the oil is hot and remove the filler plug from the top of the gearbox to give optimum oil flow.

Note: In gearboxes with brakes, brake lubrication is provided by the gearbox lubricant.

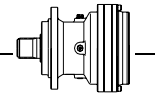

5.0 PLUG POSITIONS:

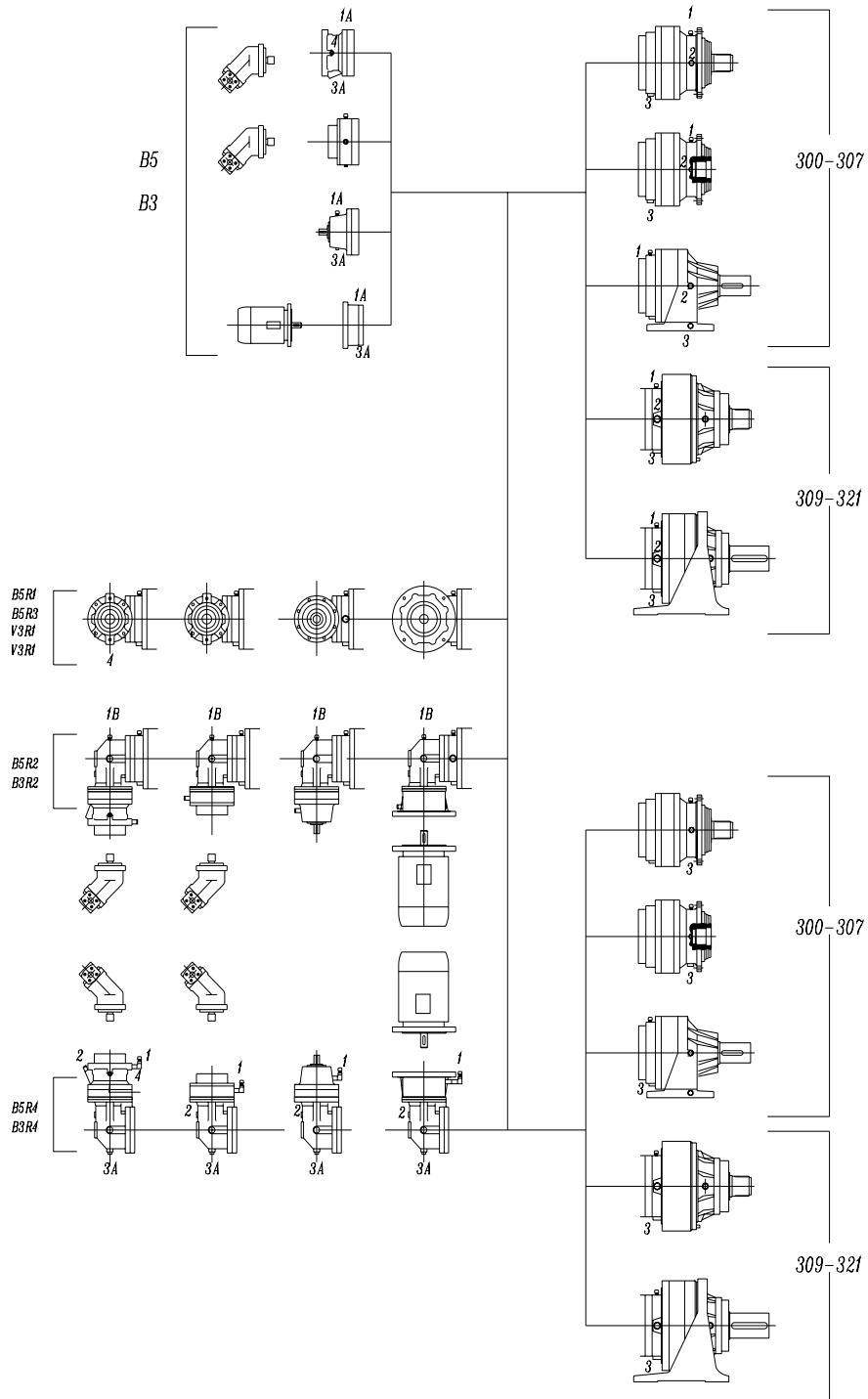

- 1, 1A, 1B: Filling/breather oil plug
- 2, 2A: Oil level plug
- 3, 3A: Oil draining plug
- 4, Brake port

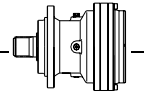

PLUG POSITIONS

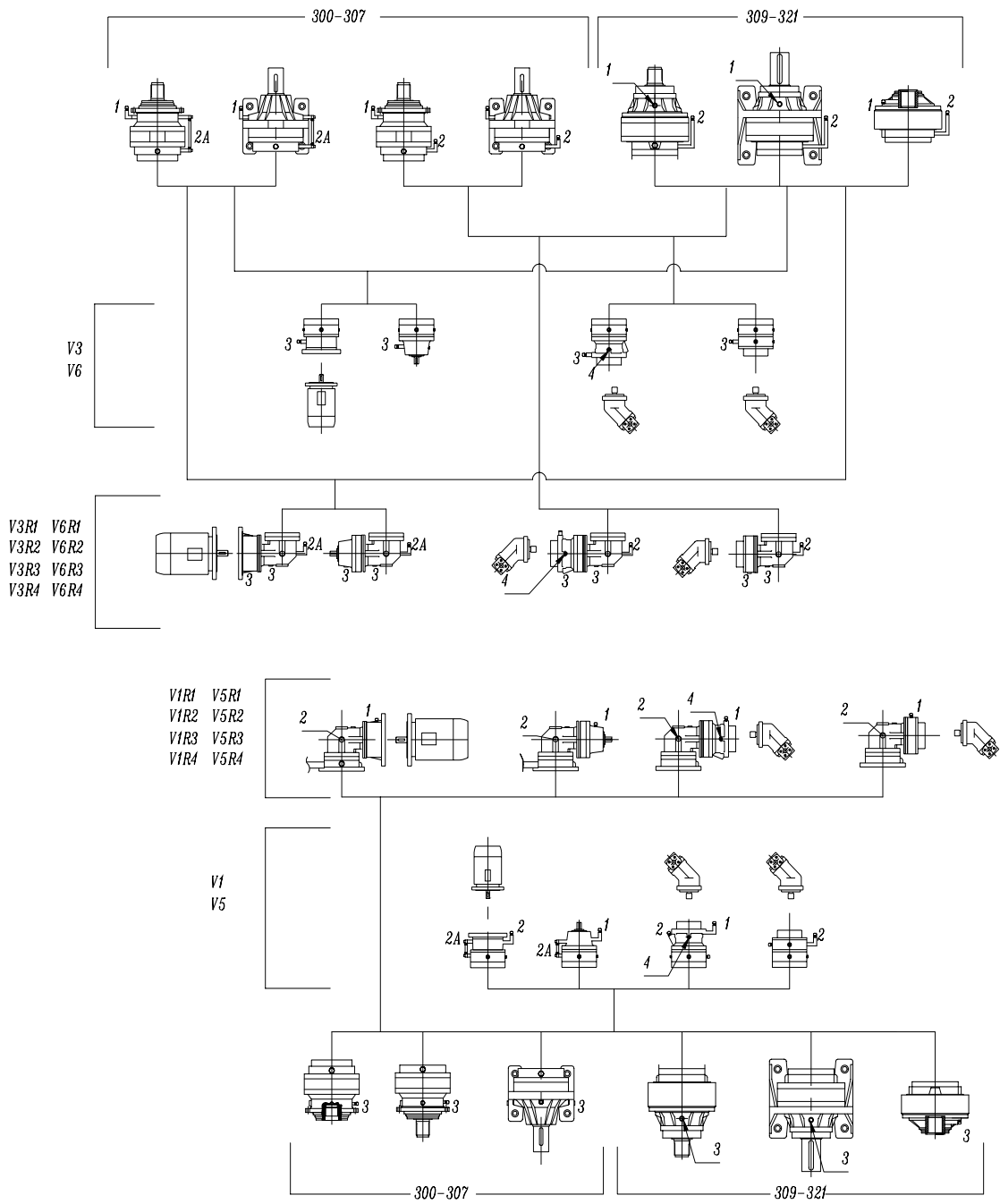

- 1, 1A, 1B: Filling/breather oil plug
- 2, 2A: Oil level plug
- 3, 3A: Oil draining plug
- 4, Brake port

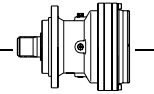

6.0 REFERENCE OIL QUANTITY: (L)

Table 9:

TYPE		In - Line			TYPE		Right angle		
		Mounting position					Mounting position		
		B5,B3	V1,V5	V3,V6			B5R,B3R	V1R,V5R	V3R,V6R
300	L1	0.6	1.0	0.9	300	R2	1.2	1.7	1.5
	L2	0.9	1.3	1.2		R3	1.5	2.0	1.8
	L3	1.2	1.6	1.5		R4	1.8	2.3	2.1
	L4	1.5	1.9	1.8					
301	L1	0.8	1.2	1.1	301	R2	1.6	2.1	1.9
	L2	1.1	1.5	1.4		R3	1.9	2.4	2.2
	L3	1.4	1.8	1.7		R4	2.2	2.7	2.5
	L4	1.7	2.1	2.0					
303	L1	1.3	2.3	2.0	303	R2	2.2	2.8	2.6
	L2	1.6	2.6	2.3		R3	2.5	3.1	2.9
	L3	1.9	2.9	2.6		R4	2.8	3.4	3.2
	L4	2.2	3.2	2.9					
305	L1	1.6	2.6	2.4	305	R2	2.5	3.1	2.9
	L2	2.1	3.1	2.9		R3	3.0	3.6	3.4
	L3	2.4	3.4	3.2		R4	3.3	3.0	3.7
	L4	2.7	3.7	3.5					
306	L1	2.5	3.5	3.2	306	R2	4.0	5.0	4.8
	L2	3.3	4.3	4.0		R3	4.8	5.8	5.6
	L3	3.6	4.6	4.3		R4	5.1	6.1	5.9
	L4	3.9	4.9	4.6					
307	L1	3.5	5.0	4.5	307	R2	6.0	8.0	7.0
	L2	4.5	6.0	5.5		R3	7.0	9.0	8.0
	L3	5.0	6.5	6.0		R4	7.5	9.5	8.5
	L4	5.3	6.8	6.3					
309	L1	4.0	5.5	5.0	309	R2	6.5	8.5	7.5
	L2	5.0	6.5	6.0		R3	7.5	9.5	8.5
	L3	5.5	7.0	6.5		R4	8.0	10	9
	L4	5.8	7.3	6.8					
310	L1	5.0	6.5	6.0	310	R2	10	12	11
	L2	6.3	7.8	7.3		R3	11	13	12
	L3	7.1	8.6	8.1		R4	12	14	13
	L4	7.4	8.9	8.4					
311	L1	7.0	12	10	311	R2	14	19	17
	L2	9.0	14	12		R3	16	21	19
	L3	10	15	13		R4	17	22	20
	L4	10.5	15.5	13.5					
313	L1	9.0	14	12	313	R2	16	21	19
	L2	11.5	16.5	14.5		R3	19	24	22
	L3	12.5	17.5	15.5		R4	20	25	23
	L4	13	18	16					
315	L1	15	23	19	315	R3	27	35	31
	L2	19	27	23		R4	30	38	34
	L3	21	29	25					
	L4	22	30	26					
316	L1	18	26	22	316	R3	30	38	34
	L2	22	30	26		R4	33	41	37
	L3	24	32	28					
	L4	25	33	29					

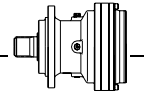

7.0 NEGATIVE MULTI DISC BRAKE

DESCRIPTION:

Our fail-safe parking brake is an oil immersed multi disc unit on the input side of the gearbox.. The brake is operated when there is no hydraulic pressure and is released when the minimum release pressure is applied.

Use of parking brake is necessary whenever the driven system must be kept at standstill even under external forces and/or torques.

Applications:

- winches
- slewing drives
- parking brake on mobile equipment
- general industrial applications

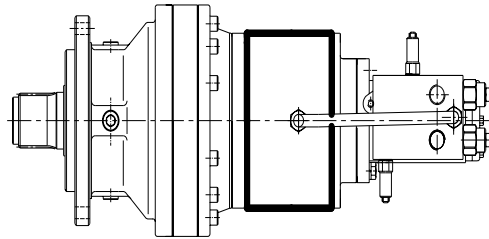
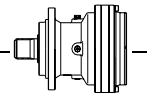

Table 10:

BRAKE TECHNICAL DATA

		TYPE																	
		4						5						6					
		A	B	D	F	H	K	L	B	C	E	G	K	B	C	E	G	K	L
Static brake torque Mb	N.m	50	100	160	260	330	400	440	400	500	630	800	1000	850	1100	1500	2100	2600	3200
Min. opening pressure	bar	10	20	30	20	25	30	35	20	28	20	26	32	15	20	25	20	25	30
Max. operating pressure	bar	320																	
Oil volume for brake release	cm³	8	8	8	8	8	8	15	15	15	15	15	15	40	40	40	40	40	40



8.0 PRODUCT IDENTIFICATION SCHEME

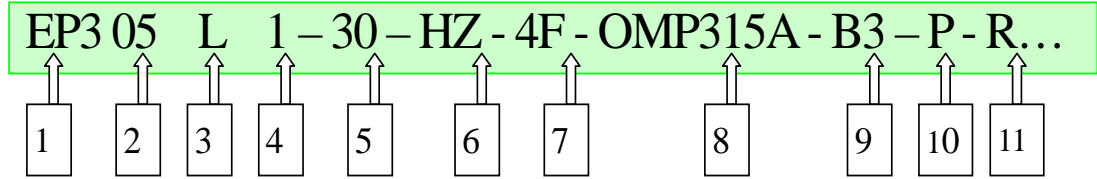

1 Produce series: EP3—Planetary drives
 EP4—Track drives
 EP6—Wheel drives
 EP7—Slewing drives

2 Gearbox size: 00,01,03,05...16

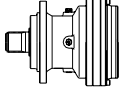
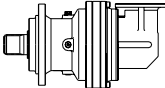
3 Design: L—Linear gearbox 
 R—Right angle 

4 No. of reductions: 1,2,3,4

5 Reduction ratio: Fill in the value of the transm. ratio (including point and decimals) reported in the selection charts

6 Output version:

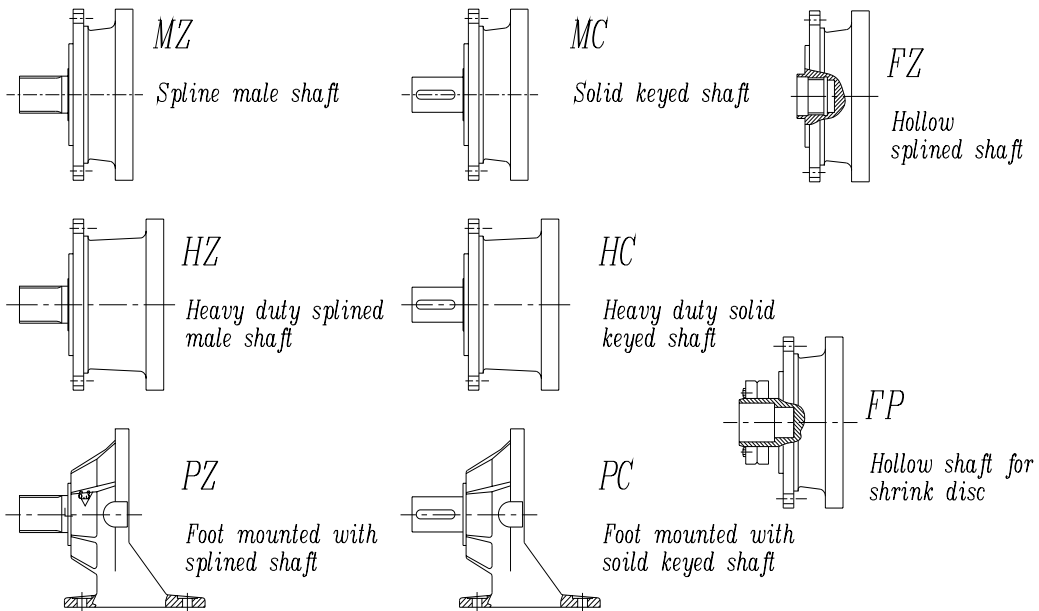

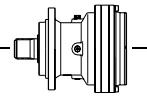

PRODUCT IDENTIFICATION SCHEME

- 7 Hydraulic brake type(only with hydraulic motor adaptor):**
 Standard negative multi disc brake: 4A,4B...4L,5B,5C...5K,6B,6C...6L (see page 24)
 Without hydraulic brake: WO

8 Input:

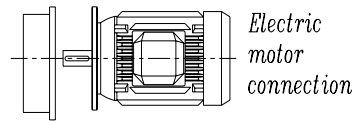
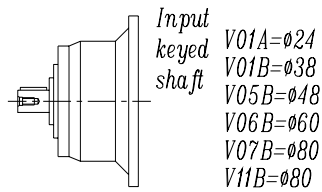

Motor size:(IEC71B5,IEC80B5...)

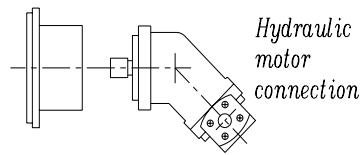

*Motor size and shaft type,flange
type:(OMP315A,EPMZ50014B1...)*

- 9 Mounting position:** See page 18,19

10 Output fittings:

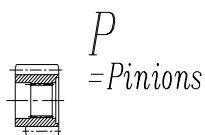
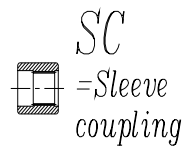
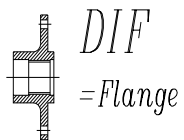

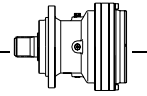

PRODUCT IDENTIFICATION SCHEME

11 Rotate direction (only for right angle design):

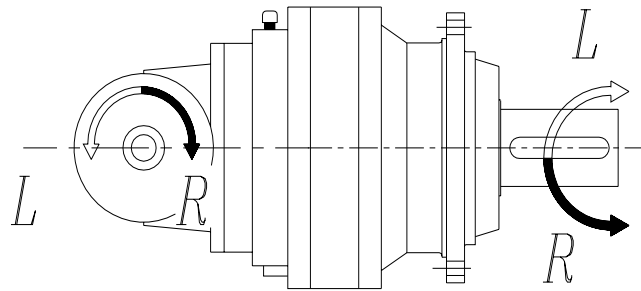

..... Option:

supplementary coolings system, etc...

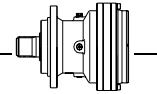

EP300 series gear motor

P1=0.12 KW n1=1400 min⁻¹

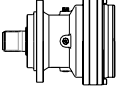
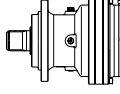
n₂ (min ⁻¹)	M₂ (N.m)	S	I 1:	P_t (KW)			IEC Motor type	Check Thermal Power Pt >= P1	Dimension Page Number
0.55	1833	1.06	2545	6.0	EP303L4	--	631-4	OK	PAGE 100
0.55	1833	1.89	2545	6.0	EP305L4	--	631-4	OK	PAGE 110
0.65	1551	1.06	2153	6.0	EP301L4	--	631-4	OK	PAGE 90
0.75	1344	1.52	1866	6.0	EP303L4	--	631-4	OK	PAGE 100
0.75	1344	2.80	1866	6.0	EP305L4	--	631-4	OK	PAGE 110
0.81	1243	1.29	1725	6.0	EP301L4	--	631-4	OK	PAGE 90
0.84	1195	1.67	1659	6.0	EP301L4	--	631-4	OK	PAGE 90
0.94	1077	2.27	1495	6.0	EP303L4	--	631-4	OK	PAGE 100
1.0	996	1.52	1383	6.0	EP301L4	--	631-4	OK	PAGE 90
1.1	957	0.98	1329	6.0	EP300L4	--	631-4	OK	PAGE 80
1.1	957	2.05	1329	6.0	EP301L4	--	631-4	OK	PAGE 90
1.1	905	3.03	1256	6.0	EP303L4	--	631-4	OK	PAGE 100
1.3	798	0.91	1108	6.0	EP300L4	--	631-4	OK	PAGE 80
1.3	798	1.89	1108	6.0	EP301L4	--	631-4	OK	PAGE 90
1.4	738	1.29	1024	6.0	EP300L4	--	631-4	OK	PAGE 80
1.4	738	2.65	1024	6.0	EP301L4	--	631-4	OK	PAGE 90
1.6	615	1.59	853	6.0	EP300L4	--	631-4	OK	PAGE 80
1.6	615	3.18	853	6.0	EP301L4	--	631-4	OK	PAGE 90
1.8	562	1.74	780	6.0	EP300L4	--	631-4	OK	PAGE 80
1.8	562	3.41	780	6.0	EP301L4	--	631-4	OK	PAGE 90
1.8	551	1.06	765	10.0	--	EP300R4	631-4	OK	PAGE 80
1.8	551	2.05	765	10.0	--	EP301R4	631-4	OK	PAGE 90
1.9	522	3.26	725	12.0	--	EP303R4	631-4	OK	PAGE 100
2.2	468	1.97	650	6.0	EP300L4	--	631-4	OK	PAGE 80
2.2	450	2.05	625	6.0	EP300L4	--	631-4	OK	PAGE 80
2.3	442	1.59	613	10.0	--	EP300R4	631-4	OK	PAGE 80
2.3	442	3.26	613	10.0	--	EP301R4	631-4	OK	PAGE 90
2.8	361	2.50	501	6.0	EP300L4	--	631-4	OK	PAGE 80
2.9	343	2.65	476	6.0	EP300L4	--	631-4	OK	PAGE 80
3.0	340	2.80	472	10.0	--	EP300R4	631-4	OK	PAGE 80
3.7	273	3.18	378	10.0	--	EP300R4	631-4	OK	PAGE 80
3.8	278	1.98	373	7.5	EP300L3	--	631-4	OK	PAGE 80
4.7	223	2.78	299	7.5	EP300L3	--	631-4	OK	PAGE 80

EP300 series gear motor

P1=0.18 KW n1=1400 min⁻¹

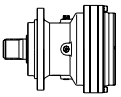
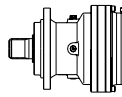
n₂ (min ⁻¹)	M₂ (N.m)	S	I i:	P₁ (KW)			IEC Motor type	Check Thermal Power Pt >= P1	Dimension Page Number
0.55	2749	1.26	2545	6.0	EP305L4	--	632-4	OK	PAGE 110
0.56	2708	2.53	2506	6.0	EP306L4	--	632-4	OK	PAGE 120
0.68	2209	3.54	2045	6.0	EP306L4	--	632-4	OK	PAGE 120
0.75	2016	1.01	1866	6.0	EP303L4	--	632-4	OK	PAGE 100
0.75	2016	1.87	1866	6.0	EP305L4	--	632-4	OK	PAGE 110
0.81	1864	0.86	1725	6.0	EP301L4	--	632-4	OK	PAGE 90
0.84	1792	1.11	1659	6.0	EP301L4	--	632-4	OK	PAGE 90
0.94	1616	1.52	1495	6.0	EP303L4	--	632-4	OK	PAGE 100
0.94	1616	2.78	1495	6.0	EP305L4	--	632-4	OK	PAGE 110
1.0	1494	1.01	1383	6.0	EP301L4	--	632-4	OK	PAGE 90
1.1	1436	1.36	1329	6.0	EP301L4	--	632-4	OK	PAGE 90
1.1	1357	2.02	1256	6.0	EP303L4	--	632-4	OK	PAGE 100
1.3	1197	1.26	1108	6.0	EP301L4	--	632-4	OK	PAGE 90
1.4	1106	0.86	1024	6.0	EP300L4	--	632-4	OK	PAGE 80
1.4	1106	1.77	1024	6.0	EP301L4	--	632-4	OK	PAGE 90
1.4	1087	2.53	1007	6.0	EP303L4	--	632-4	OK	PAGE 100
1.6	922	1.06	853	6.0	EP300L4	--	632-4	OK	PAGE 80
1.6	922	2.12	853	6.0	EP301L4	--	632-4	OK	PAGE 90
1.7	871	3.03	806	6.0	EP303L4	--	632-4	OK	PAGE 100
1.8	843	1.16	780	6.0	EP300L4	--	632-4	OK	PAGE 80
1.8	843	2.27	780	6.0	EP301L4	--	632-4	OK	PAGE 90
1.8	827	1.36	765	10.0	--	EP301R4	632-4	OK	PAGE 90
1.9	805	3.28	745	6.0	EP303L4	--	632-4	OK	PAGE 100
1.9	783	2.17	725	12.0	--	EP303R4	632-4	OK	PAGE 100
2.2	702	1.31	650	6.0	EP300L4	--	632-4	OK	PAGE 80
2.2	702	2.68	650	6.0	EP301L4	--	632-4	OK	PAGE 90
2.2	675	1.36	625	6.0	EP300L4	--	632-4	OK	PAGE 80
2.2	675	2.78	625	6.0	EP301L4	--	632-4	OK	PAGE 90
2.3	662	1.06	613	10.0	--	EP300R4	632-4	OK	PAGE 80
2.3	662	2.17	613	10.0	--	EP301R4	632-4	OK	PAGE 90
2.6	574	3.03	531	12.0	--	EP303R4	632-4	OK	PAGE 100
2.8	541	1.67	501	6.0	EP300L4	--	632-4	OK	PAGE 80
2.8	541	3.28	501	6.0	EP301L4	--	632-4	OK	PAGE 90
2.9	514	1.77	476	6.0	EP300L4	--	632-4	OK	PAGE 80
2.9	514	3.43	476	6.0	EP301L4	--	632-4	OK	PAGE 90
3.0	510	1.87	472	10.0	--	EP300R4	632-4	OK	PAGE 80
3.0	510	3.38	472	10.0	--	EP301R4	632-4	OK	PAGE 90
3.7	409	2.12	378	10.0	--	EP300R4	632-4	OK	PAGE 80
3.8	417	1.32	373	7.5	EP300L3	--	632-4	OK	PAGE 80
3.8	417	2.69	373	7.5	EP301L3	--	632-4	OK	PAGE 90
4.7	334	1.86	299	7.5	EP300L3	--	632-4	OK	PAGE 80
4.8	315	2.78	292	10.0	--	EP300R4	632-4	OK	PAGE 80
6.0	252	3.33	234	10.0	--	EP300R4	632-4	OK	PAGE 80

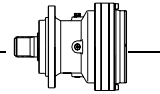

EP300 series gear motor

P1=0.25KW n1=1400 min⁻¹

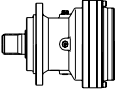
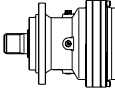
n₂ (min ⁻¹)	M₂ (N.m)	S	I 1:	P_t (KW)			IEC Motor type	Check Thermal Power Pt >= P1	Dimension Page Number
0.55	3819	0.91	2545	6.0	EP305L4	--	711-4	OK	PAGE 110
0.56	3761	1.82	2506	6.0	EP306L4	--	711-4	OK	PAGE 120
0.64	3305	2.91	2202	7.5	EP307L4	--	711-4	OK	PAGE 130
0.68	3069	2.55	2045	6.0	EP306L4	--	711-4	OK	PAGE 120
0.75	2800	1.35	1866	6.0	EP305L4	--	711-4	OK	PAGE 110
0.84	2508	2.91	1671	6.0	EP306L4	--	711-4	OK	PAGE 120
0.94	2244	1.09	1495	6.0	EP303L4	--	711-4	OK	PAGE 100
0.94	2244	2.00	1495	6.0	EP305L4	--	711-4	OK	PAGE 110
1.05	2009	3.49	1339	6.0	EP306L4	--	711-4	OK	PAGE 120
1.1	1995	0.98	1329	6.0	EP301L4	--	711-4	OK	PAGE 90
1.1	1885	1.45	1256	6.0	EP303L4	--	711-4	OK	PAGE 100
1.1	1885	2.55	1256	6.0	EP305L4	--	711-4	OK	PAGE 110
1.3	1662	0.91	1108	6.0	EP301L4	--	711-4	OK	PAGE 90
1.4	1537	1.27	1024	6.0	EP301L4	--	711-4	OK	PAGE 90
1.4	1510	1.82	1007	6.0	EP303L4	--	711-4	OK	PAGE 100
1.6	1281	1.53	853	6.0	EP301L4	--	711-4	OK	PAGE 90
1.7	1210	2.18	806	6.0	EP303L4	--	711-4	OK	PAGE 100
1.8	1170	1.64	780	6.0	EP301L4	--	711-4	OK	PAGE 90
1.8	1148	0.98	765	10.0	--	EP301R4	711-4	OK	PAGE 90
1.9	1118	2.36	745	6.0	EP303L4	--	711-4	OK	PAGE 100
1.9	1087	1.56	725	12.0	--	EP303R4	711-4	OK	PAGE 100
1.9	1087	2.73	725	12.0	--	EP305R4	711-4	OK	PAGE 110
2.2	975	0.95	650	6.0	EP300L4	--	711-4	OK	PAGE 80
2.2	975	1.93	650	6.0	EP301L4	--	711-4	OK	PAGE 90
2.2	938	0.98	625	6.0	EP300L4	--	711-4	OK	PAGE 80
2.2	938	2.00	625	6.0	EP301L4	--	711-4	OK	PAGE 90
2.3	932	2.55	621	6.0	EP303L4	--	711-4	OK	PAGE 100
2.3	920	1.56	613	10.0	--	EP301R4	711-4	OK	PAGE 90
2.6	797	2.18	531	12.0	--	EP303R4	711-4	OK	PAGE 100
2.8	751	1.20	501	6.0	EP300L4	--	711-4	OK	PAGE 80
2.8	751	2.36	501	6.0	EP301L4	--	711-4	OK	PAGE 90
2.9	714	1.27	476	6.0	EP300L4	--	711-4	OK	PAGE 80
2.9	714	2.47	476	6.0	EP301L4	--	711-4	OK	PAGE 90
3.0	710	3.27	473	6.0	EP303L4	--	711-4	OK	PAGE 100
3.0	709	1.35	472	10.0	--	EP300R4	711-4	OK	PAGE 80
3.0	709	2.44	472	10.0	--	EP301R4	711-4	OK	PAGE 90
3.3	639	3.27	426	12.0	--	EP303R4	711-4	OK	PAGE 100
3.6	579	2.91	386	6.0	EP301L4	--	711-4	OK	PAGE 90
3.7	568	1.53	378	10.0	--	EP300R4	711-4	OK	PAGE 80
3.7	568	3.09	378	10.0	--	EP301R4	711-4	OK	PAGE 90
3.8	579	0.95	373	7.5	EP300L3	--	711-4	OK	PAGE 80
3.8	579	1.93	373	7.5	EP301L3	--	711-4	OK	PAGE 90
4.0	548	2.81	353	7.5	EP303L3	--	711-4	OK	PAGE 100
4.7	464	1.34	299	7.5	EP300L3	--	711-4	OK	PAGE 80
4.8	437	2.00	292	10.0	--	EP300R4	711-4	OK	PAGE 80
6.0	351	2.40	234	10.0	--	EP300R4	711-4	OK	PAGE 80
6.1	358	2.46	230	7.5	EP300L3	--	711-4	OK	PAGE 80
6.3	333	2.55	222	10.0	--	EP300R4	711-4	OK	PAGE 80
7.6	286	2.99	185	7.5	EP300L3	--	711-4	OK	PAGE 80
7.8	270	3.09	180	10.0	--	EP300R4	711-4	OK	PAGE 80
13.2	165	3.16	106	12.0	--	EP300R3	711-4	OK	PAGE 80

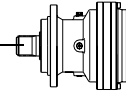

EP300 series gear motor

P1=0.37KW **n1=1400 min⁻¹**

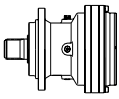
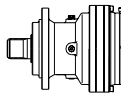
n₂ (min ⁻¹)	M₂ (N.m)	S	I 1:	P_t (KW)			IEC Motor type	Check Thermal Power Pt >= P1	Dimension Page Number
0.56	5566	1.23	2506	6.0	EP306L4	--	712-4	OK	PAGE 120
0.64	4891	1.97	2202	7.5	EP307L4	--	712-4	OK	PAGE 130
0.64	4891	3.44	2202	7.5	EP309L4	--	712-4	OK	PAGE 140
0.68	4542	1.72	2045	6.0	EP306L4	--	712-4	OK	PAGE 120
0.75	4145	0.91	1866	6.0	EP305L4	--	712-4	OK	PAGE 110
0.75	4121	2.46	1856	7.5	EP307L4	--	712-4	OK	PAGE 130
0.84	3711	1.97	1671	6.0	EP306L4	--	712-4	OK	PAGE 120
0.92	3367	2.95	1516	7.5	EP307L4	--	712-4	OK	PAGE 130
0.94	3321	1.35	1495	6.0	EP305L4	--	712-4	OK	PAGE 110
1.05	2974	2.36	1339	6.0	EP306L4	--	712-4	OK	PAGE 120
1.1	2790	0.98	1256	6.0	EP303L4	--	712-4	OK	PAGE 100
1.1	2790	1.72	1256	6.0	EP305L4	--	712-4	OK	PAGE 110
1.2	2669	2.70	1202	6.0	EP306L4	--	712-4	OK	PAGE 120
1.4	2279	3.44	1026	6.0	EP306L4	--	712-4	OK	PAGE 120
1.4	2274	0.86	1024	6.0	EP301L4	--	712-4	OK	PAGE 90
1.4	2235	1.23	1007	6.0	EP303L4	--	712-4	OK	PAGE 100
1.4	2235	2.46	1007	6.0	EP305L4	--	712-4	OK	PAGE 110
1.6	1895	1.03	853	6.0	EP301L4	--	712-4	OK	PAGE 90
1.7	1791	1.47	806	6.0	EP303L4	--	712-4	OK	PAGE 100
1.7	1791	2.95	806	6.0	EP305L4	--	712-4	OK	PAGE 110
1.8	1732	1.11	780	6.0	EP301L4	--	712-4	OK	PAGE 90
1.9	1654	1.60	745	6.0	EP303L4	--	712-4	OK	PAGE 100
1.9	1654	3.19	745	6.0	EP305L4	--	712-4	OK	PAGE 110
1.9	1609	1.06	725	12.0	--	EP303R4	712-4	OK	PAGE 100
1.9	1609	1.84	725	12.0	--	EP305R4	712-4	OK	PAGE 110
2.2	1443	1.30	650	6.0	EP301L4	--	712-4	OK	PAGE 90
2.2	1388	1.35	625	6.0	EP301L4	--	712-4	OK	PAGE 90
2.3	1380	1.72	621	6.0	EP303L4	--	712-4	OK	PAGE 100
2.3	1362	1.06	613	10.0	--	EP301R4	712-4	OK	PAGE 90
2.6	1180	1.47	531	12.0	--	EP303R4	712-4	OK	PAGE 100
2.6	1180	2.95	531	12.0	--	EP305R4	712-4	OK	PAGE 110
2.8	1112	1.60	501	6.0	EP301L4	--	712-4	OK	PAGE 90
2.9	1057	0.86	476	6.0	EP300L4	--	712-4	OK	PAGE 80
2.9	1057	1.67	476	6.0	EP301L4	--	712-4	OK	PAGE 90
3.0	1051	2.21	473	6.0	EP303L4	--	712-4	OK	PAGE 100
3.0	1049	0.91	472	10.0	--	EP300R4	712-4	OK	PAGE 80
3.0	1049	1.65	472	10.0	--	EP301R4	712-4	OK	PAGE 90
3.3	946	2.21	426	12.0	--	EP303R4	712-4	OK	PAGE 100
3.4	917	2.46	413	6.0	EP303L4	--	712-4	OK	PAGE 100
3.6	857	1.97	386	6.0	EP301L4	--	712-4	OK	PAGE 90
3.7	840	1.03	378	10.0	--	EP300R4	712-4	OK	PAGE 80
3.7	840	2.09	378	10.0	--	EP301R4	712-4	OK	PAGE 90
3.8	857	1.31	373	7.5	EP301L3	--	712-4	OK	PAGE 90
3.8	809	2.95	364	6.0	EP303L4	--	712-4	OK	PAGE 100
3.9	794	3.19	358	12.0	--	EP303R4	712-4	OK	PAGE 100
4.0	812	1.90	353	7.5	EP303L3	--	712-4	OK	PAGE 100
4.4	707	3.19	318	6.0	EP303L4	--	712-4	OK	PAGE 100
4.7	687	0.90	299	7.5	EP300L3	--	712-4	OK	PAGE 80
4.7	687	2.38	299	7.5	EP301L3	--	712-4	OK	PAGE 90
4.7	660	2.46	297	6.0	EP301L4	--	712-4	OK	PAGE 90
4.8	647	1.35	292	10.0	--	EP300R4	712-4	OK	PAGE 80

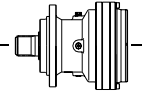

EP300 series gear motor

P1=0.37KW **n1=1400 min⁻¹**

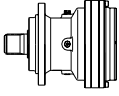
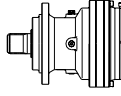
n₂ (min ⁻¹)	M₂ (N.m)	S	I 1:	P_t (KW)			IEC Motor type	Check Thermal Power Pt >= P1	Dimension Page Number
4.8	647	2.70	292	10.0	--	EP301R4	712-4	OK	PAGE 90
5.4	595	2.85	259	7.5	EP303L3	--	712-4	OK	PAGE 100
6.0	519	1.62	234	10.0	--	EP300R4	712-4	OK	PAGE 80
6.0	519	3.19	234	10.0	--	EP301R4	712-4	OK	PAGE 90
6.1	529	1.66	230	7.5	EP300L3	--	712-4	OK	PAGE 80
6.1	529	3.09	230	7.5	EP301L3	--	712-4	OK	PAGE 90
6.3	493	1.72	222	10.0	--	EP300R4	712-4	OK	PAGE 80
6.3	493	3.44	222	10.0	--	EP301R4	712-4	OK	PAGE 90
7.6	424	2.02	185	7.5	EP300L3	--	712-4	OK	PAGE 80
7.8	400	2.09	180	10.0	--	EP300R4	712-4	OK	PAGE 80
9.8	327	2.61	142	7.5	EP300L3	--	712-4	OK	PAGE 80
10.3	301	2.70	135	10.0	--	EP300R4	712-4	OK	PAGE 80
12.3	262	3.09	114	7.5	EP300L3	--	712-4	OK	PAGE 80
12.9	249	3.33	108	7.5	EP300L3	--	712-4	OK	PAGE 80
13.2	244	2.14	106	12.0	--	EP300R3	712-4	OK	PAGE 80
16.4	196	3.09	85.2	12.0	--	EP300R3	712-4	OK	PAGE 80

EP300 series gear motor

P1=0.55KW **n1=1400 min⁻¹**

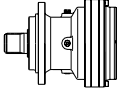
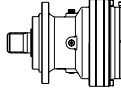
n₂ (min ⁻¹)	M₂ (N.m)	S	I 1:	P_t (KW)			IEC Motor type	Check Thermal Power Pt >= P1	Dimension Page Number
0.59	7835	2.98	2373	11.0	EP310L4	--	801-4	OK	PAGE 150
0.64	7270	1.32	2202	7.5	EP307L4	--	801-4	OK	PAGE 130
0.64	7270	2.31	2202	7.5	EP309L4	--	801-4	OK	PAGE 140
0.68	6751	1.16	2045	6.0	EP306L4	--	801-4	OK	PAGE 120
0.75	6126	1.65	1856	7.5	EP307L4	--	801-4	OK	PAGE 130
0.75	6126	2.64	1856	7.5	EP309L4	--	801-4	OK	PAGE 140
0.84	5517	1.32	1671	6.0	EP306L4	--	801-4	OK	PAGE 120
0.92	5006	1.98	1516	7.5	EP307L4	--	801-4	OK	PAGE 130
0.92	5006	3.47	1516	7.5	EP309L4	--	801-4	OK	PAGE 140
0.94	4937	0.91	1495	6.0	EP305L4	--	801-4	OK	PAGE 110
1.05	4420	1.59	1339	6.0	EP306L4	--	801-4	OK	PAGE 120
1.1	4147	1.16	1256	6.0	EP305L4	--	801-4	OK	PAGE 110
1.2	4011	2.81	1215	7.5	EP307L4	--	801-4	OK	PAGE 130
1.2	4011	2.81	1215	7.5	EP307L4	--	801-4	OK	PAGE 130
1.2	3967	1.82	1202	6.0	EP306L4	--	801-4	OK	PAGE 120
1.3	3600	3.31	1090	7.5	EP307L4	--	801-4	OK	PAGE 130
1.4	3388	2.31	1026	6.0	EP306L4	--	801-4	OK	PAGE 120
1.4	3323	1.65	1007	6.0	EP305L4	--	801-4	OK	PAGE 110
1.7	2715	2.81	822	6.0	EP306L4	--	801-4	OK	PAGE 120
1.7	2662	0.99	806	6.0	EP303L4	--	801-4	OK	PAGE 100
1.7	2662	1.98	806	6.0	EP305L4	--	801-4	OK	PAGE 110

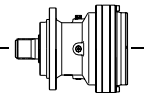

EP300 series gear motor

P1=0.55KW **n1=1400 min⁻¹**

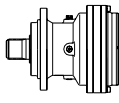
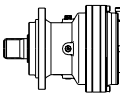
n₂ (min ⁻¹)	M₂ (N.m)	S	I 1:	P_t (KW)			IEC Motor type	Check Thermal Power Pt >= P1	Dimension Page Number
1.9	2459	1.07	745	6.0	EP303L4	--	801-4	OK	PAGE 100
1.9	2459	2.15	745	6.0	EP305L4	--	801-4	OK	PAGE 110
1.9	2392	1.24	725	12.0	--	EP305R4	801-4	OK	PAGE 110
2.0	2356	2.48	714	12.0	--	EP306R4	801-4	OK	PAGE 120
2.2	2146	0.88	650	6.0	EP301L4	--	801-4	OK	PAGE 90
2.2	2063	0.91	625	6.0	EP301L4	--	801-4	OK	PAGE 90
2.3	2051	1.16	621	6.0	EP303L4	--	801-4	OK	PAGE 100
2.3	2051	2.48	621	6.0	EP305L4	--	801-4	OK	PAGE 110
2.4	1922	3.31	582	12.0	--	EP306R4	801-4	OK	PAGE 120
2.6	1754	0.99	531	12.0	--	EP303R4	801-4	OK	PAGE 100
2.6	1754	1.98	531	12.0	--	EP305R4	801-4	OK	PAGE 110
2.8	1653	1.07	501	6.0	EP301L4	--	801-4	OK	PAGE 90
2.9	1571	1.12	476	6.0	EP301L4	--	801-4	OK	PAGE 90
3.0	1562	1.49	473	6.0	EP303L4	--	801-4	OK	PAGE 100
3.0	1562	3.31	473	6.0	EP305L4	--	801-4	OK	PAGE 110
3.0	1559	1.11	472	10.0	--	EP301R4	801-4	OK	PAGE 90
3.3	1406	1.49	426	12.0	--	EP303R4	801-4	OK	PAGE 100
3.3	1406	3.14	426	12.0	--	EP305R4	801-4	OK	PAGE 110
3.4	1364	1.65	413	6.0	EP303L4	--	801-4	OK	PAGE 100
3.6	1273	1.32	386	6.0	EP301L4	--	801-4	OK	PAGE 90
3.7	1249	1.40	378	10.0	--	EP301R4	801-4	OK	PAGE 90
3.8	1274	0.88	373	7.5	EP301L3	--	801-4	OK	PAGE 90
3.8	1203	1.98	364	6.0	EP303L4	--	801-4	OK	PAGE 100
3.9	1181	2.15	358	12.0	--	EP303R4	801-4	OK	PAGE 100
4.0	1207	1.28	353	7.5	EP303L3	--	801-4	OK	PAGE 100
4.0	1207	2.40	353	7.5	EP305L3	--	801-4	OK	PAGE 110
4.4	1050	2.15	318	6.0	EP303L4	--	801-4	OK	PAGE 100
4.7	1021	1.60	299	7.5	EP301L3	--	801-4	OK	PAGE 90
4.7	981	1.65	297	6.0	EP301L4	--	801-4	OK	PAGE 90
4.8	962	0.91	292	10.0	--	EP300R4	801-4	OK	PAGE 80
4.8	962	1.82	292	10.0	--	EP301R4	801-4	OK	PAGE 90
4.9	946	2.64	287	12.0	--	EP303R4	801-4	OK	PAGE 100
5.0	916	2.48	278	6.0	EP303L4	--	801-4	OK	PAGE 100
5.4	885	1.92	259	7.5	EP303L3	--	801-4	OK	PAGE 100
6.0	771	1.09	234	10.0	--	EP300R4	801-4	OK	PAGE 80
6.0	771	2.15	234	10.0	--	EP301R4	801-4	OK	PAGE 90
6.1	787	1.12	230	7.5	EP300L3	--	801-4	OK	PAGE 80
6.1	787	2.08	230	7.5	EP301L3	--	801-4	OK	PAGE 90
6.3	733	1.16	222	10.0	--	EP300R4	801-4	OK	PAGE 80
6.3	733	2.31	222	10.0	--	EP301R4	801-4	OK	PAGE 90
6.3	729	3.31	221	12.0	--	EP303R4	801-4	OK	PAGE 100
6.7	709	2.88	208	7.5	EP303L3	--	801-4	OK	PAGE 100
7.6	630	1.36	185	7.5	EP300L3	--	801-4	OK	PAGE 80
7.6	630	2.56	185	7.5	EP301L3	--	801-4	OK	PAGE 90
7.8	594	1.40	180	10.0	--	EP300R4	801-4	OK	PAGE 80
7.8	594	2.81	180	10.0	--	EP301R4	801-4	OK	PAGE 90
9.8	486	1.76	142	7.5	EP300L3	--	801-4	OK	PAGE 80
9.8	486	3.20	142	7.5	EP301L3	--	801-4	OK	PAGE 90
10.3	447	1.82	135	10.0	--	EP300R4	801-4	OK	PAGE 80
12.3	389	2.08	114	7.5	EP300L3	--	801-4	OK	PAGE 80
12.9	370	2.24	108	7.5	EP300L3	--	801-4	OK	PAGE 80

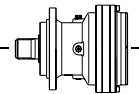

EP300 series gear motor

P1=0.55KW **n1=1400 min⁻¹**

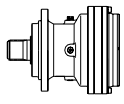
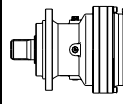
n₂ (min ⁻¹)	M₂ (N.m)	S	I 1:	P_t (KW)			IEC Motor type	Check Thermal Power Pt >= P1	Dimension Page Number
13.2	363	1.44	106	12.0	--	EP300R3	801-4	OK	PAGE 80
13.2	363	3.04	106	12.0	--	EP301R3	801-4	OK	PAGE 90
13.4	345	2.31	104	10.0	--	EP300R4	801-4	OK	PAGE 80
15.9	300	2.72	87.8	7.5	EP300L3	--	801-4	OK	PAGE 80
16.4	291	2.08	85.2	12.0	--	EP300R3	801-4	OK	PAGE 80
17.6	262	2.98	79.5	10.0	--	EP300R4	801-4	OK	PAGE 80
27.0	183	2.94	51.8	7.5	EP300L2	--	801-4	OK	PAGE 80

EP300 series gear motor

P1=0.75KW **n1=1400 min⁻¹**

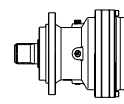
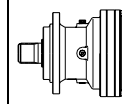
n₂ (min ⁻¹)	M₂ (N.m)	S	I 1:	P_t (KW)			IEC Motor type	Check Thermal Power Pt >= P1	Dimension Page Number
0.59	10684	2.18	2373	11.0	EP310L4	--	802-4	OK	PAGE 150
0.64	9914	0.97	2202	7.5	EP307L4	--	802-4	OK	PAGE 130
0.64	9914	1.70	2202	7.5	EP309L4	--	802-4	OK	PAGE 140
0.68	9206	0.85	2045	6.0	EP306L4	--	802-4	OK	PAGE 120
0.72	8718	2.67	1937	11.0	EP310L4	--	802-4	OK	PAGE 150
0.75	8353	1.21	1856	7.5	EP307L4	--	802-4	OK	PAGE 130
0.75	8353	1.94	1856	7.5	EP309L4	--	802-4	OK	PAGE 140
0.84	7523	0.97	1671	6.0	EP306L4	--	802-4	OK	PAGE 120
0.88	7124	3.03	1582	11.0	EP310L4	--	802-4	OK	PAGE 150
0.92	6826	1.45	1516	7.5	EP307L4	--	802-4	OK	PAGE 130
0.92	6826	2.55	1516	7.5	EP309L4	--	802-4	OK	PAGE 140
1.05	6028	1.16	1339	6.0	EP306L4	--	802-4	OK	PAGE 120
1.1	5655	0.85	1256	6.0	EP305L4	--	802-4	OK	PAGE 110
1.2	5470	2.06	1215	7.5	EP307L4	--	802-4	OK	PAGE 130
1.2	5470	2.06	1215	7.5	EP307L4	--	802-4	OK	PAGE 130
1.2	5470	3.03	1215	7.5	EP309L4	--	802-4	OK	PAGE 140
1.2	5409	1.33	1202	6.0	EP306L4	--	802-4	OK	PAGE 120
1.3	4909	2.42	1090	7.5	EP307L4	--	802-4	OK	PAGE 130
1.3	4909	3.27	1090	7.5	EP309L4	--	802-4	OK	PAGE 140
1.4	4620	1.70	1026	6.0	EP306L4	--	802-4	OK	PAGE 120
1.4	4531	1.21	1007	6.0	EP305L4	--	802-4	OK	PAGE 110
1.5	4114	2.67	914	7.5	EP307L4	--	802-4	OK	PAGE 130
1.7	3702	2.06	822	6.0	EP306L4	--	802-4	OK	PAGE 120
1.7	3631	1.45	806	6.0	EP305L4	--	802-4	OK	PAGE 110
1.8	3456	3.15	768	7.5	EP307L4	--	802-4	OK	PAGE 130
1.9	3353	1.58	745	6.0	EP305L4	--	802-4	OK	PAGE 110
1.9	3291	2.91	731	6.0	EP306L4	--	802-4	OK	PAGE 120
1.9	3262	0.91	725	12.0	--	EP305R4	802-4	OK	PAGE 110
2.0	3212	1.82	714	12.0	--	EP306R4	802-4	OK	PAGE 120
2.2	2823	3.03	627	14.0	--	EP307R4	802-4	OK	PAGE 130
2.3	2797	0.85	621	6.0	EP303L4	--	802-4	OK	PAGE 100
2.3	2797	1.82	621	6.0	EP305L4	--	802-4	OK	PAGE 110
2.4	2637	3.52	586	6.0	EP306L4	--	802-4	OK	PAGE 120
2.4	2621	2.42	582	12.0	--	EP306R4	802-4	OK	PAGE 120

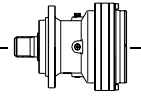

EP300 series gear motor

P1=0.75KW n1=1400 min⁻¹

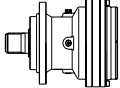
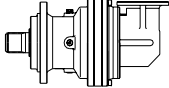
n₂ (min ⁻¹)	M₂ (N.m)	S	I 1:	P₁ (KW)			IEC Motor type	Check Thermal Power Pt >= P1	Dimension Page Number
2.6	2392	1.45	531	12.0	--	EP305R4	802-4	OK	PAGE 110
2.9	2142	2.91	476	12.0	--	EP306R4	802-4	OK	PAGE 120
3.0	2130	1.09	473	6.0	EP303L4	--	802-4	OK	PAGE 100
3.0	2130	2.42	473	6.0	EP305L4	--	802-4	OK	PAGE 110
3.3	1917	1.09	426	12.0	--	EP303R4	802-4	OK	PAGE 100
3.3	1917	2.30	426	12.0	--	EP305R4	802-4	OK	PAGE 110
3.4	1859	1.21	413	6.0	EP303L4	--	802-4	OK	PAGE 100
3.4	1859	2.79	413	6.0	EP305L4	--	802-4	OK	PAGE 110
3.6	1736	0.97	386	6.0	EP301L4	--	802-4	OK	PAGE 90
3.7	1716	3.52	381	12.0	--	EP306R4	802-4	OK	PAGE 120
3.7	1704	1.03	378	10.0	--	EP301R4	802-4	OK	PAGE 90
3.8	1641	1.45	364	6.0	EP303L4	--	802-4	OK	PAGE 100
3.8	1641	3.15	364	6.0	EP305L4	--	802-4	OK	PAGE 110
3.9	1610	1.58	358	12.0	--	EP303R4	802-4	OK	PAGE 100
3.9	1610	3.15	358	12.0	--	EP305R4	802-4	OK	PAGE 110
4.0	1645	0.94	353	7.5	EP303L3	--	802-4	OK	PAGE 100
4.0	1645	1.76	353	7.5	EP305L3	--	802-4	OK	PAGE 110
4.0	1620	3.28	348	7.5	EP306L3	--	802-4	OK	PAGE 120
4.4	1432	1.58	318	6.0	EP303L4	--	802-4	OK	PAGE 100
4.7	1392	1.17	299	7.5	EP301L3	--	802-4	OK	PAGE 90
4.7	1338	1.21	297	6.0	EP301L4	--	802-4	OK	PAGE 90
4.8	1312	1.33	292	10.0	--	EP301R4	802-4	OK	PAGE 90
4.9	1290	1.94	287	12.0	--	EP303R4	802-4	OK	PAGE 100
5.0	1250	1.82	278	6.0	EP303L4	--	802-4	OK	PAGE 100
5.4	1207	1.41	259	7.5	EP303L3	--	802-4	OK	PAGE 100
5.4	1207	2.81	259	7.5	EP305L3	--	802-4	OK	PAGE 110
6.0	1052	1.58	234	10.0	--	EP301R4	802-4	OK	PAGE 90
6.1	1073	1.52	230	7.5	EP301L3	--	802-4	OK	PAGE 90
6.3	1000	0.85	222	10.0	--	EP300R4	802-4	OK	PAGE 80
6.3	1000	1.70	222	10.0	--	EP301R4	802-4	OK	PAGE 90
6.3	994	2.42	221	12.0	--	EP303R4	802-4	OK	PAGE 100
6.7	967	2.11	208	7.5	EP303L3	--	802-4	OK	PAGE 100
7.6	859	1.00	185	7.5	EP300L3	--	802-4	OK	PAGE 80
7.6	859	1.88	185	7.5	EP301L3	--	802-4	OK	PAGE 90
7.8	810	1.03	180	10.0	--	EP300R4	802-4	OK	PAGE 80
7.8	810	2.06	180	10.0	--	EP301R4	802-4	OK	PAGE 90
8.0	812	3.05	174	7.5	EP303L3	--	802-4	OK	PAGE 100
8.3	757	3.15	168	12.0	--	EP303R4	802-4	OK	PAGE 100
9.8	662	1.29	142	7.5	EP300L3	--	802-4	OK	PAGE 80
9.8	662	2.34	142	7.5	EP301L3	--	802-4	OK	PAGE 90
10.3	610	1.33	135	10.0	--	EP300R4	802-4	OK	PAGE 80
10.3	610	2.67	135	10.0	--	EP301R4	802-4	OK	PAGE 90
12.3	531	1.52	114	7.5	EP300L3	--	802-4	OK	PAGE 80
12.3	531	2.81	114	7.5	EP301L3	--	802-4	OK	PAGE 90
12.9	504	1.64	108	7.5	EP300L3	--	802-4	OK	PAGE 80
12.9	504	2.93	108	7.5	EP301L3	--	802-4	OK	PAGE 90
13.2	495	1.05	106	12.0	--	EP300R3	802-4	OK	PAGE 80
13.2	495	2.23	106	12.0	--	EP301R3	802-4	OK	PAGE 90
13.4	470	1.70	104	10.0	--	EP300R4	802-4	OK	PAGE 80
13.4	470	3.27	104	10.0	--	EP301R4	802-4	OK	PAGE 90
15.9	409	1.99	87.8	7.5	EP300L3	--	802-4	OK	PAGE 80

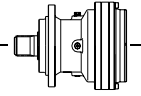

EP300 series gear motor

P1=0.75KW n1=1400 min⁻¹

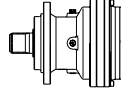
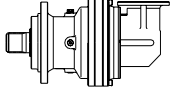
n₂ (min ⁻¹)	M₂ (N.m)	S	I 1:	P_t (KW)			IEC Motor type	Check Thermal Power Pt >= P1	Dimension Page Number
16.4	396	1.52	85.2	12.0	--	EP300R3	802-4	OK	PAGE 80
16.4	396	3.16	85.2	12.0	--	EP301R3	802-4	OK	PAGE 90
17.6	358	2.18	79.5	10.0	--	EP300R4	802-4	OK	PAGE 80
21.2	308	2.58	66.1	7.5	EP300L3	--	802-4	OK	PAGE 80
21.3	305	2.58	65.6	12.0	--	EP300R3	802-4	OK	PAGE 80
26.6	245	3.16	52.6	12.0	--	EP300R3	802-4	OK	PAGE 80
27.0	249	2.16	51.8	7.5	EP300L2	--	802-4	OK	PAGE 80
27.5	237	3.28	50.9	7.5	EP300L3	--	802-4	OK	PAGE 80
33.7	200	3.18	41.5	7.5	EP300L2	--	802-4	OK	PAGE 80

EP300 series gear motor

P1=1.1KW n1=1400 min⁻¹

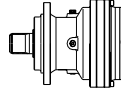
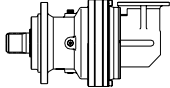
n₂ (min ⁻¹)	M₂ (N.m)	S	I 1:	P_t (KW)			IEC Motor type	Check Thermal Power Pt >= P1	Dimension Page Number
0.59	15670	1.49	2373	11.0	EP310L4	--	90S-4	OK	PAGE 150
0.64	14541	1.16	2202	7.5	EP309L4	--	90S-4	OK	PAGE 140
0.72	12786	1.82	1937	11.0	EP310L4	--	90S-4	OK	PAGE 150
0.73	12583	2.56	1906	11.0	EP311L4	--	90S-4	OK	PAGE 160
0.75	12252	1.32	1856	7.5	EP309L4	--	90S-4	OK	PAGE 140
0.87	10602	3.55	1606	11.0	EP311L4	--	90S-4	OK	PAGE 160
0.88	10448	2.07	1582	11.0	EP310L4	--	90S-4	OK	PAGE 150
0.92	10011	0.99	1516	7.5	EP307L4	--	90S-4	OK	PAGE 130
0.92	10011	1.74	1516	7.5	EP309L4	--	90S-4	OK	PAGE 140
1.0	9376	2.73	1420	11.0	EP310L4	--	90S-4	OK	PAGE 150
1.1	8372	2.48	1268	11.0	EP310L4	--	90S-4	OK	PAGE 150
1.2	8022	1.40	1215	7.5	EP307L4	--	90S-4	OK	PAGE 130
1.2	8022	1.40	1215	7.5	EP307L4	--	90S-4	OK	PAGE 130
1.2	8022	2.07	1215	7.5	EP309L4	--	90S-4	OK	PAGE 140
1.2	7934	0.91	1202	6.0	EP306L4	--	90S-4	OK	PAGE 120
1.2	7662	3.14	1160	11.0	EP310L4	--	90S-4	OK	PAGE 150
1.3	7199	1.65	1090	7.5	EP307L4	--	90S-4	OK	PAGE 130
1.3	7199	2.23	1090	7.5	EP309L4	--	90S-4	OK	PAGE 140
1.4	6776	1.16	1026	6.0	EP306L4	--	90S-4	OK	PAGE 120
1.5	6034	1.82	914	7.5	EP307L4	--	90S-4	OK	PAGE 130
1.5	6034	2.73	914	7.5	EP309L4	--	90S-4	OK	PAGE 140
1.7	5577	3.55	845	14.0	--	EP310R4	90S-4	OK	PAGE 150
1.7	5429	1.40	822	6.0	EP306L4	--	90S-4	OK	PAGE 120
1.7	5325	0.99	806	6.0	EP305L4	--	90S-4	OK	PAGE 110
1.8	5068	2.15	768	7.5	EP307L4	--	90S-4	OK	PAGE 130
1.9	4918	1.07	745	6.0	EP305L4	--	90S-4	OK	PAGE 110
1.9	4827	1.98	731	6.0	EP306L4	--	90S-4	OK	PAGE 120
2.0	4712	1.24	714	12.0	--	EP306R4	90S-4	OK	PAGE 120
2.2	4140	2.07	627	14.0	--	EP307R4	90S-4	OK	PAGE 130
2.2	4140	3.31	627	14.0	--	EP309R4	90S-4	OK	PAGE 140
2.3	4102	1.24	621	6.0	EP305L4	--	90S-4	OK	PAGE 110
2.4	3904	2.73	591	7.5	EP307L4	--	90S-4	OK	PAGE 130
2.4	3868	2.40	586	6.0	EP306L4	--	90S-4	OK	PAGE 120

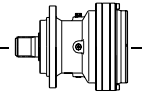

EP300 series gear motor

P1=1.1KW n1=1400 min⁻¹

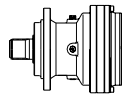
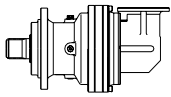
n₂ (min ⁻¹)	M₂ (N.m)	S	I I:	P_t (KW)			IEC Motor type	Check Thermal Power Pt >= P1	Dimension Page Number
2.4	3844	1.65	582	12.0	--	EP306R4	90S-4	OK	PAGE 120
2.6	3508	0.99	531	12.0	--	EP305R4	90S-4	OK	PAGE 110
2.6	3488	2.73	528	14.0	--	EP307R4	90S-4	OK	PAGE 130
2.9	3141	1.98	476	12.0	--	EP306R4	90S-4	OK	PAGE 120
3.0	3129	3.31	474	7.5	EP307L4	--	90S-4	OK	PAGE 130
3.0	3124	1.65	473	6.0	EP305L4	--	90S-4	OK	PAGE 110
3.1	2980	3.14	451	6.0	EP306L4	--	90S-4	OK	PAGE 120
3.2	2850	3.31	432	14.0	--	EP307R4	90S-4	OK	PAGE 130
3.3	2811	1.57	426	12.0	--	EP305R4	90S-4	OK	PAGE 110
3.4	2727	1.90	413	6.0	EP305L4	--	90S-4	OK	PAGE 110
3.7	2517	2.40	381	12.0	--	EP306R4	90S-4	OK	PAGE 120
3.8	2407	0.99	364	6.0	EP303L4	--	90S-4	OK	PAGE 100
3.8	2407	2.15	364	6.0	EP305L4	--	90S-4	OK	PAGE 110
3.9	2361	1.07	358	12.0	--	EP303R4	90S-4	OK	PAGE 100
3.9	2361	2.15	358	12.0	--	EP305R4	90S-4	OK	PAGE 110
4.0	2413	1.20	353	7.5	EP305L3	--	90S-4	OK	PAGE 110
4.0	2377	2.24	348	7.5	EP306L3	--	90S-4	OK	PAGE 120
4.1	2259	2.64	342	12.0	--	EP306R4	90S-4	OK	PAGE 120
4.4	2101	1.07	318	6.0	EP303L4	--	90S-4	OK	PAGE 100
4.4	2101	2.40	318	6.0	EP305L4	--	90S-4	OK	PAGE 110
4.8	1925	0.91	292	10.0	--	EP301R4	90S-4	OK	PAGE 90
4.9	1892	1.32	287	12.0	--	EP303R4	90S-4	OK	PAGE 100
4.9	1892	2.73	287	12.0	--	EP305R4	90S-4	OK	PAGE 110
4.9	1939	3.36	284	7.5	EP306L3	--	90S-4	OK	PAGE 120
5.0	1833	1.24	278	6.0	EP303L4	--	90S-4	OK	PAGE 100
5.0	1833	2.73	278	6.0	EP305L4	--	90S-4	OK	PAGE 110
5.4	1770	0.96	259	7.5	EP303L3	--	90S-4	OK	PAGE 100
5.4	1770	1.92	259	7.5	EP305L3	--	90S-4	OK	PAGE 110
6.0	1542	1.07	234	10.0	--	EP301R4	90S-4	OK	PAGE 90
6.1	1573	1.04	230	7.5	EP301L3	--	90S-4	OK	PAGE 90
6.3	1466	1.16	222	10.0	--	EP301R4	90S-4	OK	PAGE 90
6.3	1458	1.65	221	12.0	--	EP303R4	90S-4	OK	PAGE 100
6.3	1458	3.31	221	12.0	--	EP305R4	90S-4	OK	PAGE 110
6.7	1418	1.44	208	7.5	EP303L3	--	90S-4	OK	PAGE 100
6.7	1418	3.04	208	7.5	EP305L3	--	90S-4	OK	PAGE 110
7.6	1260	1.28	185	7.5	EP301L3	--	90S-4	OK	PAGE 90
7.8	1188	1.40	180	10.0	--	EP301R4	90S-4	OK	PAGE 90
8.0	1191	2.08	174	7.5	EP303L3	--	90S-4	OK	PAGE 100
8.3	1110	2.15	168	12.0	--	EP303R4	90S-4	OK	PAGE 100
9.5	969	2.40	147	12.0	--	EP303R4	90S-4	OK	PAGE 100
9.8	971	0.88	142	7.5	EP300L3	--	90S-4	OK	PAGE 80
9.8	971	1.60	142	7.5	EP301L3	--	90S-4	OK	PAGE 90
10.0	954	2.56	140	7.5	EP303L3	--	90S-4	OK	PAGE 100
10.3	895	0.91	135	10.0	--	EP300R4	90S-4	OK	PAGE 80
10.3	895	1.82	135	10.0	--	EP301R4	90S-4	OK	PAGE 90
10.8	855	2.64	130	12.0	--	EP303R4	90S-4	OK	PAGE 100
12.3	778	1.04	114	7.5	EP300L3	--	90S-4	OK	PAGE 80
12.3	778	1.92	114	7.5	EP301L3	--	90S-4	OK	PAGE 90
12.4	747	2.98	113	12.0	--	EP303R4	90S-4	OK	PAGE 100
12.9	739	1.12	108	7.5	EP300L3	--	90S-4	OK	PAGE 80
12.9	739	2.00	108	7.5	EP301L3	--	90S-4	OK	PAGE 90

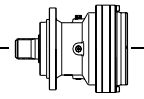

EP300 series gear motor

P1=1.1KW n1=1400 min⁻¹

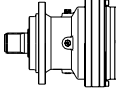
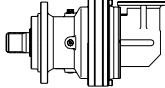
n₂ (min ⁻¹)	M₂ (N.m)	S	I i:	P_t (KW)			IEC Motor type	Check Thermal Power Pt >= P1	Dimension Page Number
13.0	735	3.20	108	7.5	EP303L3	--	90S-4	OK	PAGE 100
13.2	726	1.52	106	12.0	--	EP301R3	90S-4	OK	PAGE 90
13.4	689	1.16	104	10.0	--	EP300R4	90S-4	OK	PAGE 80
13.4	689	2.23	104	10.0	--	EP301R4	90S-4	OK	PAGE 90
13.9	687	2.40	101	14.0	--	EP303R3	90S-4	OK	PAGE 100
14.2	651	3.31	98.6	12.0	--	EP303R4	90S-4	OK	PAGE 100
15.9	599	1.36	87.8	7.5	EP300L3	--	90S-4	OK	PAGE 80
15.9	599	2.40	87.8	7.5	EP301L3	--	90S-4	OK	PAGE 90
16.4	581	1.04	85.2	12.0	--	EP300R3	90S-4	OK	PAGE 80
16.4	581	2.16	85.2	12.0	--	EP301R3	90S-4	OK	PAGE 90
17.0	561	2.96	82.2	14.0	--	EP303R3	90S-4	OK	PAGE 100
17.6	525	1.49	79.5	10.0	--	EP300R4	90S-4	OK	PAGE 80
17.6	525	2.89	79.5	10.0	--	EP301R4	90S-4	OK	PAGE 90
19.0	504	3.36	73.8	14.0	--	EP303R3	90S-4	OK	PAGE 100
21.2	451	1.76	66.1	7.5	EP300L3	--	90S-4	OK	PAGE 80
21.2	451	3.04	66.1	7.5	EP301L3	--	90S-4	OK	PAGE 90
21.3	448	1.76	65.6	12.0	--	EP300R3	90S-4	OK	PAGE 80
21.3	448	3.28	65.6	12.0	--	EP301R3	90S-4	OK	PAGE 90
26.6	359	2.16	52.6	12.0	--	EP300R3	90S-4	OK	PAGE 80
27.0	366	1.47	51.8	7.5	EP300L2	--	90S-4	OK	PAGE 80
27.0	366	2.79	51.8	7.5	EP301L2	--	90S-4	OK	PAGE 90
27.5	348	2.24	50.9	7.5	EP300L3	--	90S-4	OK	PAGE 80
33.7	293	2.17	41.5	7.5	EP300L2	--	90S-4	OK	PAGE 80
34.6	276	2.64	40.5	12.0	--	EP300R3	90S-4	OK	PAGE 80
36.1	265	2.80	38.8	7.5	EP300L3	--	90S-4	OK	PAGE 80
43.8	226	3.17	32.0	7.5	EP300L2	--	90S-4	OK	PAGE 80
45.4	211	3.36	30.8	12.0	--	EP300R3	90S-4	OK	PAGE 80

EP300 series gear motor

P1=1.5KW n1=1400 min⁻¹

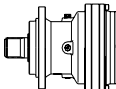
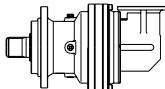
n₂ (min ⁻¹)	M₂ (N.m)	S	I i:	P_t (KW)			IEC Motor type	Check Thermal Power Pt >= P1	Dimension Page Number
0.59	21369	1.09	2373	11.0	EP310L4	--	90L-4	OK	PAGE 150
0.64	19828	0.85	2202	7.5	EP309L4	--	90L-4	OK	PAGE 140
0.72	17435	1.33	1937	11.0	EP310L4	--	90L-4	OK	PAGE 150
0.73	17159	1.88	1906	11.0	EP311L4	--	90L-4	OK	PAGE 160
0.75	16735	2.73	1859	11.0	EP313L4	--	90L-4	OK	PAGE 170
0.75	16707	0.97	1856	7.5	EP309L4	--	90L-4	OK	PAGE 140
0.87	14458	2.61	1606	11.0	EP311L4	--	90L-4	OK	PAGE 160
0.88	14247	1.52	1582	11.0	EP310L4	--	90L-4	OK	PAGE 150
0.89	14114	3.45	1568	11.0	EP313L4	--	90L-4	OK	PAGE 170
0.92	13652	1.27	1516	7.5	EP309L4	--	90L-4	OK	PAGE 140
1.0	12786	2.00	1420	11.0	EP310L4	--	90L-4	OK	PAGE 150
1.0	12182	3.03	1353	11.0	EP311L4	--	90L-4	OK	PAGE 160
1.1	11416	1.82	1268	11.0	EP310L4	--	90L-4	OK	PAGE 150
1.2	10939	1.03	1215	7.5	EP307L4	--	90L-4	OK	PAGE 130
1.2	10939	1.52	1215	7.5	EP309L4	--	90L-4	OK	PAGE 140

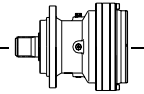

EP300 series gear motor

P1=1.5KW n1=1400 min⁻¹

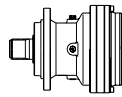
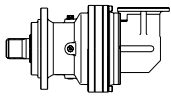
n₂ (min ⁻¹)	M₂ (N.m)	S	I i:	P_t (KW)			IEC Motor type	Check Thermal Power Pt >= P1	Dimension Page Number
1.2	10448	2.30	1160	11.0	EP310L4	--	90L-4	OK	PAGE 150
1.3	9817	1.21	1090	7.5	EP307L4	--	90L-4	OK	PAGE 130
1.3	9817	1.64	1090	7.5	EP309L4	--	90L-4	OK	PAGE 140
1.4	9240	0.85	1026	6.0	EP306L4	--	90L-4	OK	PAGE 120
1.5	8372	2.67	930	11.0	EP310L4	--	90L-4	OK	PAGE 150
1.5	8228	1.33	914	7.5	EP307L4	--	90L-4	OK	PAGE 130
1.5	8228	2.00	914	7.5	EP309L4	--	90L-4	OK	PAGE 140
1.7	7605	2.61	845	14.0	--	EP310R4	90L-4	OK	PAGE 150
1.7	7513	2.91	834	11.0	EP310L4	--	90L-4	OK	PAGE 150
1.7	7404	1.03	822	6.0	EP306L4	--	90L-4	OK	PAGE 120
1.8	6911	1.58	768	7.5	EP307L4	--	90L-4	OK	PAGE 130
1.8	6911	2.73	768	7.5	EP309L4	--	90L-4	OK	PAGE 140
1.9	6582	1.45	731	6.0	EP306L4	--	90L-4	OK	PAGE 120
2.0	6425	0.91	714	12.0	--	EP306R4	90L-4	OK	PAGE 120
2.0	6416	3.39	713	11.0	EP310L4	--	90L-4	OK	PAGE 150
2.0	6205	3.03	689	14.0	--	EP310R4	90L-4	OK	PAGE 150
2.2	5645	1.52	627	14.0	--	EP307R4	90L-4	OK	PAGE 130
2.2	5645	2.42	627	14.0	--	EP309R4	90L-4	OK	PAGE 140
2.3	5594	0.91	621	6.0	EP305L4	--	90L-4	OK	PAGE 110
2.4	5324	2.00	591	7.5	EP307L4	--	90L-4	OK	PAGE 130
2.4	5324	3.33	591	7.5	EP309L4	--	90L-4	OK	PAGE 140
2.4	5274	1.76	586	6.0	EP306L4	--	90L-4	OK	PAGE 120
2.4	5242	1.21	582	12.0	--	EP306R4	90L-4	OK	PAGE 120
2.5	5071	3.64	563	14.0	--	EP310R4	90L-4	OK	PAGE 150
2.6	4757	2.00	528	14.0	--	EP307R4	90L-4	OK	PAGE 130
2.6	4757	2.73	528	14.0	--	EP309R4	90L-4	OK	PAGE 140
2.9	4284	1.45	476	12.0	--	EP306R4	90L-4	OK	PAGE 120
3.0	4266	2.42	474	7.5	EP307L4	--	90L-4	OK	PAGE 130
3.0	4260	1.21	473	6.0	EP305L4	--	90L-4	OK	PAGE 110
3.1	4063	2.30	451	6.0	EP306L4	--	90L-4	OK	PAGE 120
3.2	3887	2.42	432	14.0	--	EP307R4	90L-4	OK	PAGE 130
3.3	3833	1.15	426	12.0	--	EP305R4	90L-4	OK	PAGE 110
3.4	3719	1.39	413	6.0	EP305L4	--	90L-4	OK	PAGE 110
3.7	3432	1.76	381	12.0	--	EP306R4	90L-4	OK	PAGE 120
3.8	3287	3.03	365	7.5	EP307L4	--	90L-4	OK	PAGE 130
3.8	3282	1.58	364	6.0	EP305L4	--	90L-4	OK	PAGE 110
3.9	3220	1.58	358	12.0	--	EP305R4	90L-4	OK	PAGE 110
4.0	3291	0.88	353	7.5	EP305L3	--	90L-4	OK	PAGE 110
4.0	3241	1.64	348	7.5	EP306L3	--	90L-4	OK	PAGE 120
4.0	3115	3.03	346	14.0	--	EP307R4	90L-4	OK	PAGE 130
4.1	3094	2.97	344	6.0	EP306L4	--	90L-4	OK	PAGE 120
4.1	3080	1.94	342	12.0	--	EP306R4	90L-4	OK	PAGE 120
4.4	2865	1.76	318	6.0	EP305L4	--	90L-4	OK	PAGE 110
4.5	2795	3.33	310	14.0	--	EP307R4	90L-4	OK	PAGE 130
4.6	2848	2.93	306	11.0	EP307L3	--	90L-4	OK	PAGE 130
4.8	2631	2.91	292	12.0	--	EP306R4	90L-4	OK	PAGE 120
4.9	2580	0.97	287	12.0	--	EP303R4	90L-4	OK	PAGE 100
4.9	2580	2.00	287	12.0	--	EP305R4	90L-4	OK	PAGE 110
4.9	2644	2.46	284	7.5	EP306L3	--	90L-4	OK	PAGE 120
5.0	2499	0.91	278	6.0	EP303L4	--	90L-4	OK	PAGE 100
5.0	2499	2.00	278	6.0	EP305L4	--	90L-4	OK	PAGE 110

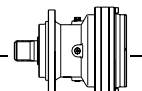

EP300 series gear motor

P1=1.5KW n1=1400 min⁻¹

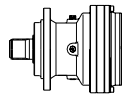
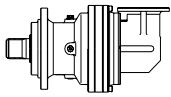
n₂ (min ⁻¹)	M₂ (N.m)	S	I i:	P_t (KW)			IEC Motor type	Check Thermal Power Pt >= P1	Dimension Page Number
5.4	2413	1.41	259	7.5	EP305L3	--	90L-4	OK	PAGE 110
6.0	2161	2.99	232	7.5	EP306L3	--	90L-4	OK	PAGE 120
6.3	1999	0.85	222	10.0	--	EP301R4	90L-4	OK	PAGE 90
6.3	1988	1.21	221	12.0	--	EP303R4	90L-4	OK	PAGE 100
6.3	1988	2.42	221	12.0	--	EP305R4	90L-4	OK	PAGE 110
6.7	1934	1.05	208	7.5	EP303L3	--	90L-4	OK	PAGE 100
6.7	1934	2.23	208	7.5	EP305L3	--	90L-4	OK	PAGE 110
7.6	1719	0.94	185	7.5	EP301L3	--	90L-4	OK	PAGE 90
7.8	1620	1.03	180	10.0	--	EP301R4	90L-4	OK	PAGE 90
8.0	1624	1.52	174	7.5	EP303L3	--	90L-4	OK	PAGE 100
8.0	1624	2.93	174	7.5	EP305L3	--	90L-4	OK	PAGE 110
8.3	1514	1.58	168	12.0	--	EP303R4	90L-4	OK	PAGE 100
8.3	1514	2.73	168	12.0	--	EP305R4	90L-4	OK	PAGE 110
9.5	1321	1.76	147	12.0	--	EP303R4	90L-4	OK	PAGE 100
9.5	1321	3.03	147	12.0	--	EP305R4	90L-4	OK	PAGE 110
9.8	1324	1.17	142	7.5	EP301L3	--	90L-4	OK	PAGE 90
10.0	1302	1.88	140	7.5	EP303L3	--	90L-4	OK	PAGE 100
10.3	1220	1.33	135	10.0	--	EP301R4	90L-4	OK	PAGE 90
10.8	1166	1.94	130	12.0	--	EP303R4	90L-4	OK	PAGE 100
10.8	1166	3.33	130	12.0	--	EP305R4	90L-4	OK	PAGE 110
12.3	1061	1.41	114	7.5	EP301L3	--	90L-4	OK	PAGE 90
12.4	1018	2.18	113	12.0	--	EP303R4	90L-4	OK	PAGE 100
12.9	1008	1.47	108	7.5	EP301L3	--	90L-4	OK	PAGE 90
13.0	1003	2.34	108	7.5	EP303L3	--	90L-4	OK	PAGE 100
13.2	989	1.11	106	12.0	--	EP301R3	90L-4	OK	PAGE 90
13.4	940	0.85	104	10.0	--	EP300R4	90L-4	OK	PAGE 80
13.4	940	1.64	104	10.0	--	EP301R4	90L-4	OK	PAGE 90
13.9	937	1.76	101	14.0	--	EP303R3	90L-4	OK	PAGE 100
13.9	937	3.11	101	14.0	--	EP305R3	90L-4	OK	PAGE 110
14.2	888	2.42	98.6	12.0	--	EP303R4	90L-4	OK	PAGE 100
15.9	817	1.00	87.8	7.5	EP300L3	--	90L-4	OK	PAGE 80
15.9	817	1.76	87.8	7.5	EP301L3	--	90L-4	OK	PAGE 90
16.4	793	1.58	85.2	12.0	--	EP301R3	90L-4	OK	PAGE 90
17.0	766	2.17	82.2	14.0	--	EP303R3	90L-4	OK	PAGE 100
17.1	764	2.93	82.0	7.5	EP303L3	--	90L-4	OK	PAGE 100
17.6	716	1.09	79.5	10.0	--	EP300R4	90L-4	OK	PAGE 80
17.6	716	2.12	79.5	10.0	--	EP301R4	90L-4	OK	PAGE 90
19.0	687	2.46	73.8	14.0	--	EP303R3	90L-4	OK	PAGE 100
19.6	667	3.22	71.6	7.5	EP303L3	--	90L-4	OK	PAGE 100
21.2	615	1.29	66.1	7.5	EP300L3	--	90L-4	OK	PAGE 80
21.2	615	2.23	66.1	7.5	EP301L3	--	90L-4	OK	PAGE 90
21.2	613	2.64	65.9	14.0	--	EP303R3	90L-4	OK	PAGE 100
21.3	611	1.29	65.6	12.0	--	EP300R3	90L-4	OK	PAGE 80
21.3	611	2.40	65.6	12.0	--	EP301R3	90L-4	OK	PAGE 90
22.8	573	3.28	61.5	14.0	--	EP303R3	90L-4	OK	PAGE 100
23.7	551	2.81	59.1	14.0	--	EP303R3	90L-4	OK	PAGE 100
26.6	489	1.58	52.6	12.0	--	EP300R3	90L-4	OK	PAGE 80
26.6	489	2.93	52.6	12.0	--	EP301R3	90L-4	OK	PAGE 90
27.0	499	1.08	51.8	7.5	EP300L2	--	90L-4	OK	PAGE 80
27.0	499	2.04	51.8	7.5	EP301L2	--	90L-4	OK	PAGE 90
27.5	474	1.64	50.9	7.5	EP300L3	--	90L-4	OK	PAGE 80

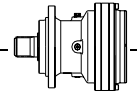

EP300 series gear motor

P1=1.5KW **n1=1400 min⁻¹**

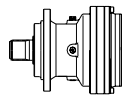
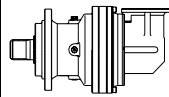
n₂ (min ⁻¹)	M₂ (N.m)	S	I I:	P_t (KW)			IEC Motor type	Check Thermal Power Pt >= P1	Dimension Page Number
27.5	474	2.87	50.9	7.5	EP301L3	--	90L-4	OK	PAGE 90
28.5	472	3.40	49.1	9.0	EP303L2	--	90L-4	OK	PAGE 100
33.7	399	1.59	41.5	7.5	EP300L2	--	90L-4	OK	PAGE 80
33.7	399	2.95	41.5	7.5	EP301L2	--	90L-4	OK	PAGE 90
34.6	377	1.93	40.5	12.0	--	EP300R3	90L-4	OK	PAGE 80
36.1	361	2.05	38.8	7.5	EP300L3	--	90L-4	OK	PAGE 80
43.8	308	2.33	32.0	7.5	EP300L2	--	90L-4	OK	PAGE 80
45.4	287	2.46	30.8	12.0	--	EP300R3	90L-4	OK	PAGE 80
54.6	247	2.84	25.6	7.5	EP300L2	--	90L-4	OK	PAGE 80
59.6	219	2.93	23.5	12.0	--	EP300R3	90L-4	OK	PAGE 80
94.9	142	2.84	14.8	12.0	--	EP300R2	90L-4	OK	PAGE 80

EP300 series gear motor

P1=2.2KW **n1=1400 min⁻¹**

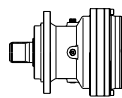
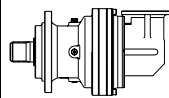
n₂ (min ⁻¹)	M₂ (N.m)	S	I I:	P_t (KW)			IEC Motor type	Check Thermal Power Pt >= P1	Dimension Page Number
0.7	27122	2.89	2054	18.0	EP315L4	--	100L1-4	OK	PAGE 180
0.72	25572	0.91	1937	11.0	EP310L4	--	100L1-4	OK	PAGE 150
0.73	25166	1.28	1906	11.0	EP311L4	--	100L1-4	OK	PAGE 160
0.75	24545	1.86	1859	11.0	EP313L4	--	100L1-4	OK	PAGE 170
0.87	21205	1.78	1606	11.0	EP311L4	--	100L1-4	OK	PAGE 160
0.88	20896	1.03	1582	11.0	EP310L4	--	100L1-4	OK	PAGE 150
0.89	20700	2.36	1568	11.0	EP313L4	--	100L1-4	OK	PAGE 170
0.92	20023	0.87	1516	7.5	EP309L4	--	100L1-4	OK	PAGE 140
1.0	18753	1.36	1420	11.0	EP310L4	--	100L1-4	OK	PAGE 150
1.0	17867	2.07	1353	11.0	EP311L4	--	100L1-4	OK	PAGE 160
1.1	17442	2.77	1321	11.0	EP313L4	--	100L1-4	OK	PAGE 170
1.1	16743	1.24	1268	11.0	EP310L4	--	100L1-4	OK	PAGE 150
1.2	16044	1.03	1215	7.5	EP309L4	--	100L1-4	OK	PAGE 140
1.2	15324	1.57	1160	11.0	EP310L4	--	100L1-4	OK	PAGE 150
1.3	14600	2.48	1106	11.0	EP311L4	--	100L1-4	OK	PAGE 160
1.3	14398	1.12	1090	7.5	EP309L4	--	100L1-4	OK	PAGE 140
1.3	14252	3.31	1079	11.0	EP313L4	--	100L1-4	OK	PAGE 170
1.5	12279	1.82	930	11.0	EP310L4	--	100L1-4	OK	PAGE 150
1.5	12067	0.91	914	7.5	EP307L4	--	100L1-4	OK	PAGE 130
1.5	12067	1.36	914	7.5	EP309L4	--	100L1-4	OK	PAGE 140
1.6	11699	3.02	886	11.0	EP311L4	--	100L1-4	OK	PAGE 160
1.7	11154	1.78	845	14.0	--	EP310R4	100L1-4	OK	PAGE 150
1.7	11019	1.98	834	11.0	EP310L4	--	100L1-4	OK	PAGE 150
1.8	10499	3.31	795	11.0	EP311L4	--	100L1-4	OK	PAGE 160
1.8	10136	1.07	768	7.5	EP307L4	--	100L1-4	OK	PAGE 130
1.8	10136	1.86	768	7.5	EP309L4	--	100L1-4	OK	PAGE 140
1.9	9654	0.99	731	6.0	EP306L4	--	100L1-4	OK	PAGE 120
2.0	9411	2.31	713	11.0	EP310L4	--	100L1-4	OK	PAGE 150
2.0	9101	2.07	689	14.0	--	EP310R4	100L1-4	OK	PAGE 150
2.2	8280	1.03	627	14.0	--	EP307R4	100L1-4	OK	PAGE 130
2.2	8280	1.65	627	14.0	--	EP309R4	100L1-4	OK	PAGE 140

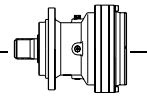

EP300 series gear motor

P1=2.2KW n1=1400 min⁻¹

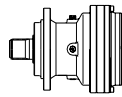
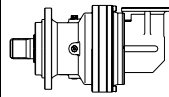
n₂ (min ⁻¹)	M₂ (N.m)	S	I I:	P_t (KW)			IEC Motor type	Check Thermal Power Pt >= P1	Dimension Page Number
2.3	7981	2.69	604	11.0	EP310L4	--	100L1-4	OK	PAGE 150
2.4	7809	1.36	591	7.5	EP307L4	--	100L1-4	OK	PAGE 130
2.4	7809	2.27	591	7.5	EP309L4	--	100L1-4	OK	PAGE 140
2.4	7735	1.20	586	6.0	EP306L4	--	100L1-4	OK	PAGE 120
2.5	7437	2.48	563	14.0	--	EP310R4	100L1-4	OK	PAGE 150
2.6	6977	1.36	528	14.0	--	EP307R4	100L1-4	OK	PAGE 130
2.6	6977	1.86	528	14.0	--	EP309R4	100L1-4	OK	PAGE 140
2.8	6704	3.51	508	11.0	EP310L4	--	100L1-4	OK	PAGE 150
2.8	6674	3.18	505	14.0	--	EP310R4	100L1-4	OK	PAGE 150
2.9	6283	0.99	476	12.0	--	EP306R4	100L1-4	OK	PAGE 120
3.0	6257	1.65	474	7.5	EP307L4	--	100L1-4	OK	PAGE 130
3.0	6257	2.69	474	7.5	EP309L4	--	100L1-4	OK	PAGE 140
3.1	5959	1.57	451	6.0	EP306L4	--	100L1-4	OK	PAGE 120
3.2	5701	1.65	432	14.0	--	EP307R4	100L1-4	OK	PAGE 130
3.2	5701	2.89	432	14.0	--	EP309R4	100L1-4	OK	PAGE 140
3.4	5454	0.95	413	6.0	EP305L4	--	100L1-4	OK	PAGE 110
3.7	5034	1.20	381	12.0	--	EP306R4	100L1-4	OK	PAGE 120
3.8	4820	2.07	365	7.5	EP307L4	--	100L1-4	OK	PAGE 130
3.8	4820	3.31	365	7.5	EP309L4	--	100L1-4	OK	PAGE 140
3.8	4813	1.07	364	6.0	EP305L4	--	100L1-4	OK	PAGE 110
3.9	4723	1.07	358	12.0	--	EP305R4	100L1-4	OK	PAGE 110
4.0	4753	1.12	348	7.5	EP306L3	--	100L1-4	OK	PAGE 120
4.0	4753	1.12	348	7.5	EP306L3	--	100L1-4	OK	PAGE 120
4.0	4568	2.07	346	14.0	--	EP307R4	100L1-4	OK	PAGE 130
4.0	4568	3.31	346	14.0	--	EP309R4	100L1-4	OK	PAGE 140
4.1	4538	2.02	344	6.0	EP306L4	--	100L1-4	OK	PAGE 120
4.1	4518	1.32	342	12.0	--	EP306R4	100L1-4	OK	PAGE 120
4.4	4202	1.20	318	6.0	EP305L4	--	100L1-4	OK	PAGE 110
4.5	4100	2.27	310	14.0	--	EP307R4	100L1-4	OK	PAGE 130
4.6	4177	2.00	306	11.0	EP307L3	--	100L1-4	OK	PAGE 130
4.6	4177	2.80	306	11.0	EP309L3	--	100L1-4	OK	PAGE 140
4.8	3858	1.98	292	12.0	--	EP306R4	100L1-4	OK	PAGE 120
4.9	3784	1.36	287	12.0	--	EP305R4	100L1-4	OK	PAGE 110
4.9	3878	1.68	284	7.5	EP306L3	--	100L1-4	OK	PAGE 120
4.9	3878	1.68	284	7.5	EP306L3	--	100L1-4	OK	PAGE 120
5.0	3671	2.48	278	7.5	EP307L4	--	100L1-4	OK	PAGE 130
5.0	3665	1.36	278	6.0	EP305L4	--	100L1-4	OK	PAGE 110
5.3	3479	2.56	263	6.0	EP306L4	--	100L1-4	OK	PAGE 120
5.4	3436	2.48	260	14.0	--	EP307R4	100L1-4	OK	PAGE 130
5.4	3539	0.96	259	7.5	EP305L3	--	100L1-4	OK	PAGE 110
5.4	3519	2.80	258	11.0	EP307L3	--	100L1-4	OK	PAGE 130
6.0	3169	2.04	232	7.5	EP306L3	--	100L1-4	OK	PAGE 120
6.0	3169	2.04	232	7.5	EP306L3	--	100L1-4	OK	PAGE 120
6.3	2915	1.65	221	12.0	--	EP305R4	100L1-4	OK	PAGE 110
6.4	2886	2.89	219	14.0	--	EP307R4	100L1-4	OK	PAGE 130
6.6	2876	3.20	211	11.0	EP307L3	--	100L1-4	OK	PAGE 130
6.7	2749	3.10	208	12.0	--	EP306R4	100L1-4	OK	PAGE 120
6.7	2836	1.52	208	7.5	EP305L3	--	100L1-4	OK	PAGE 110
6.9	2680	3.31	203	6.0	EP306L4	--	100L1-4	OK	PAGE 120
8.0	2382	1.04	174	7.5	EP303L3	--	100L1-4	OK	PAGE 100
8.0	2382	2.00	174	7.5	EP305L3	--	100L1-4	OK	PAGE 110

EP300 series gear motor

P1=2.2KW n1=1400 min⁻¹

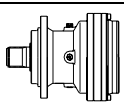
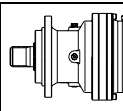
n₂ (min ⁻¹)	M₂ (N.m)	S	I I:	P_t (KW)			IEC Motor type	Check Thermal Power Pt >= P1	Dimension Page Number
8.3	2220	1.07	168	12.0	--	EP303R4	100L1-4	OK	PAGE 100
8.3	2220	1.86	168	12.0	--	EP305R4	100L1-4	OK	PAGE 110
8.4	2279	2.76	167	7.5	EP306L3	--	100L1-4	OK	PAGE 120
8.4	2279	2.76	167	7.5	EP306L3	--	100L1-4	OK	PAGE 120
9.5	1938	1.20	147	12.0	--	EP303R4	100L1-4	OK	PAGE 100
9.5	1938	2.07	147	12.0	--	EP305R4	100L1-4	OK	PAGE 110
10.0	1909	1.28	140	7.5	EP303L3	--	100L1-4	OK	PAGE 100
10.0	1909	2.48	140	7.5	EP305L3	--	100L1-4	OK	PAGE 110
10.3	1789	0.91	135	10.0	--	EP301R4	100L1-4	OK	PAGE 90
10.8	1710	1.32	130	12.0	--	EP303R4	100L1-4	OK	PAGE 100
10.8	1710	2.27	130	12.0	--	EP305R4	100L1-4	OK	PAGE 110
12.3	1556	0.96	114	7.5	EP301L3	--	100L1-4	OK	PAGE 90
12.4	1493	1.49	113	12.0	--	EP303R4	100L1-4	OK	PAGE 100
12.4	1493	2.52	113	12.0	--	EP305R4	100L1-4	OK	PAGE 110
12.9	1479	1.00	108	7.5	EP301L3	--	100L1-4	OK	PAGE 90
13.0	1471	1.60	108	7.5	EP303L3	--	100L1-4	OK	PAGE 100
13.0	1471	2.80	108	7.5	EP305L3	--	100L1-4	OK	PAGE 110
13.4	1378	1.12	104	10.0	--	EP301R4	100L1-4	OK	PAGE 90
13.9	1374	1.20	101	14.0	--	EP303R3	100L1-4	OK	PAGE 100
13.9	1374	2.12	101	14.0	--	EP305R3	100L1-4	OK	PAGE 110
14.2	1302	1.65	98.6	12.0	--	EP303R4	100L1-4	OK	PAGE 100
14.2	1302	2.89	98.6	12.0	--	EP305R4	100L1-4	OK	PAGE 110
15.9	1199	1.20	87.8	7.5	EP301L3	--	100L1-4	OK	PAGE 90
16.4	1163	1.08	85.2	12.0	--	EP301R3	100L1-4	OK	PAGE 90
17.0	1123	1.48	82.2	14.0	--	EP303R3	100L1-4	OK	PAGE 100
17.0	1123	2.80	82.2	14.0	--	EP305R3	100L1-4	OK	PAGE 110
17.1	1120	2.00	82.0	7.5	EP303L3	--	100L1-4	OK	PAGE 100
17.6	1050	1.45	79.5	10.0	--	EP301R4	100L1-4	OK	PAGE 90
19.0	1008	1.68	73.8	14.0	--	EP303R3	100L1-4	OK	PAGE 100
19.6	978	2.20	71.6	7.5	EP303L3	--	100L1-4	OK	PAGE 100
21.2	902	0.88	66.1	7.5	EP300L3	--	100L1-4	OK	PAGE 80
21.2	902	1.52	66.1	7.5	EP301L3	--	100L1-4	OK	PAGE 90
21.2	900	1.80	65.9	14.0	--	EP303R3	100L1-4	OK	PAGE 100
21.3	896	0.88	65.6	12.0	--	EP300R3	100L1-4	OK	PAGE 80
21.3	896	1.64	65.6	12.0	--	EP301R3	100L1-4	OK	PAGE 90
22.2	863	2.48	63.2	7.5	EP303L3	--	100L1-4	OK	PAGE 100
22.8	840	2.24	61.5	14.0	--	EP303R3	100L1-4	OK	PAGE 100
23.7	807	1.92	59.1	14.0	--	EP303R3	100L1-4	OK	PAGE 100
25.4	753	2.80	55.2	7.5	EP303L3	--	100L1-4	OK	PAGE 100
26.6	718	1.08	52.6	12.0	--	EP300R3	100L1-4	OK	PAGE 80
26.6	718	2.00	52.6	12.0	--	EP301R3	100L1-4	OK	PAGE 90
27.0	709	2.72	51.9	14.0	--	EP303R3	100L1-4	OK	PAGE 100
27.0	731	1.39	51.8	7.5	EP301L2	--	100L1-4	OK	PAGE 90
27.5	695	1.12	50.9	7.5	EP300L3	--	100L1-4	OK	PAGE 80
27.5	695	1.96	50.9	7.5	EP301L3	--	100L1-4	OK	PAGE 90
28.2	678	3.48	49.7	14.0	--	EP303R3	100L1-4	OK	PAGE 100
28.5	692	2.32	49.1	9.0	EP303L2	--	100L1-4	OK	PAGE 100
29.1	657	3.20	48.1	7.5	EP303L3	--	100L1-4	OK	PAGE 100
33.7	586	1.08	41.5	7.5	EP300L2	--	100L1-4	OK	PAGE 80
33.7	586	2.01	41.5	7.5	EP301L2	--	100L1-4	OK	PAGE 90
34.6	553	1.32	40.5	12.0	--	EP300R3	100L1-4	OK	PAGE 80

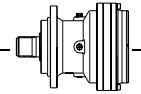

EP300 series gear motor

P1=2.2KW **n1=1400 min⁻¹**

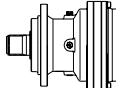
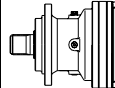
n₂ (min ⁻¹)	M₂ (N.m)	S	I i:	P_t (KW)			IEC Motor type	Check Thermal Power Pt >= P1	Dimension Page Number
34.6	553	2.52	40.5	12.0	--	EP301R3	100L1-4	OK	PAGE 90
34.9	566	3.09	40.1	9.0	EP303L2	--	100L1-4	OK	PAGE 100
36.1	529	1.40	38.8	7.5	EP300L3	--	100L1-4	OK	PAGE 80
36.1	529	2.40	38.8	7.5	EP301L3	--	100L1-4	OK	PAGE 90
43.8	451	1.59	32.0	7.5	EP300L2	--	100L1-4	OK	PAGE 80
43.8	451	2.90	32.0	7.5	EP301L2	--	100L1-4	OK	PAGE 90
45.4	421	1.68	30.8	12.0	--	EP300R3	100L1-4	OK	PAGE 80
45.4	421	3.08	30.8	12.0	--	EP301R3	100L1-4	OK	PAGE 90
54.6	362	1.93	25.6	7.5	EP300L2	--	100L1-4	OK	PAGE 80
54.6	362	3.17	25.6	7.5	EP301L2	--	100L1-4	OK	PAGE 90
59.6	321	2.00	23.5	12.0	--	EP300R3	100L1-4	OK	PAGE 80
59.6	321	3.20	23.5	12.0	--	EP301R3	100L1-4	OK	PAGE 90
70.9	279	2.40	19.8	7.5	EP300L2	--	100L1-4	OK	PAGE 80
93.1	212	2.90	15.0	7.5	EP300L2	--	100L1-4	OK	PAGE 80
94.9	208	1.93	14.8	12.0	--	EP300R2	100L1-4	OK	PAGE 80
118	167	2.90	11.8	12.0	--	EP300R2	100L1-4	OK	PAGE 80

EP300 series gear motor

P1=3.0KW **n1=1400 min⁻¹**

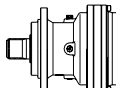
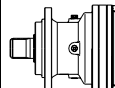
n₂ (min ⁻¹)	M₂ (N.m)	S	I i:	P_t (KW)			IEC Motor type	Check Thermal Power Pt >= P1	Dimension Page Number
0.7	36984	2.12	2054	18.0	EP315L4	--	100L2-4	OK	PAGE 180
0.73	34318	0.94	1906	11.0	EP311L4	--	100L2-4	OK	PAGE 160
0.75	33470	1.36	1859	11.0	EP313L4	--	100L2-4	OK	PAGE 170
0.8	31162	2.73	1731	18.0	EP315L4	--	100L2-4	OK	PAGE 180
0.87	28916	1.30	1606	11.0	EP311L4	--	100L2-4	OK	PAGE 160
0.89	28227	1.73	1568	11.0	EP313L4	--	100L2-4	OK	PAGE 170
1.0	25572	1.00	1420	11.0	EP310L4	--	100L2-4	OK	PAGE 150
1.0	25427	3.18	1412	18.0	EP315L4	--	100L2-4	OK	PAGE 180
1.0	24364	1.52	1353	11.0	EP311L4	--	100L2-4	OK	PAGE 160
1.1	23784	2.03	1321	11.0	EP313L4	--	100L2-4	OK	PAGE 170
1.1	22832	0.91	1268	11.0	EP310L4	--	100L2-4	OK	PAGE 150
1.1	22129	3.18	1229	18.0	EP315L4	--	100L2-4	OK	PAGE 180
1.2	20896	1.15	1160	11.0	EP310L4	--	100L2-4	OK	PAGE 150
1.3	19909	1.82	1106	11.0	EP311L4	--	100L2-4	OK	PAGE 160
1.3	19435	2.42	1079	11.0	EP313L4	--	100L2-4	OK	PAGE 170
1.5	16743	1.33	930	11.0	EP310L4	--	100L2-4	OK	PAGE 150
1.5	16455	1.00	914	7.5	EP309L4	--	100L2-4	OK	PAGE 140
1.6	15953	2.21	886	11.0	EP311L4	--	100L2-4	OK	PAGE 160
1.6	15573	2.73	865	11.0	EP313L4	--	100L2-4	OK	PAGE 170
1.7	15210	1.30	845	14.0	--	EP310R4	100L2-4	OK	PAGE 150
1.7	15026	1.45	834	11.0	EP310L4	--	100L2-4	OK	PAGE 150
1.8	14317	2.42	795	11.0	EP311L4	--	100L2-4	OK	PAGE 160
1.8	13976	3.03	776	11.0	EP313L4	--	100L2-4	OK	PAGE 170
1.8	13822	1.36	768	7.5	EP309L4	--	100L2-4	OK	PAGE 140
2.0	12833	1.70	713	11.0	EP310L4	--	100L2-4	OK	PAGE 150
2.0	12411	1.52	689	14.0	--	EP310R4	100L2-4	OK	PAGE 150

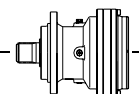

EP300 series gear motor

P1=3.0KW n1=1400 min⁻¹

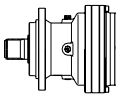
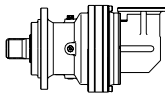
n₂ (min ⁻¹)	M₂ (N.m)	S	I I:	P_t (KW)			IEC Motor type	Check Thermal Power Pt >= P1	Dimension Page Number
2.1	11999	2.88	666	11.0	EP311L4	--	100L2-4	OK	PAGE 160
2.1	11912	3.33	662	22.0	--	EP313R4	100L2-4	OK	PAGE 170
2.2	11291	1.21	627	14.0	--	EP309R4	100L2-4	OK	PAGE 140
2.3	10883	1.97	604	11.0	EP310L4	--	100L2-4	OK	PAGE 150
2.4	10648	1.00	591	7.5	EP307L4	--	100L2-4	OK	PAGE 130
2.4	10648	1.67	591	7.5	EP309L4	--	100L2-4	OK	PAGE 140
2.4	10548	0.88	586	6.0	EP306L4	--	100L2-4	OK	PAGE 120
2.5	10141	1.82	563	14.0	--	EP310R4	100L2-4	OK	PAGE 150
2.5	10079	3.39	560	11.0	EP311L4	--	100L2-4	OK	PAGE 160
2.6	9771	2.88	543	22.0	--	EP311R4	100L2-4	OK	PAGE 160
2.6	9514	1.00	528	14.0	--	EP307R4	100L2-4	OK	PAGE 130
2.6	9514	1.36	528	14.0	--	EP309R4	100L2-4	OK	PAGE 140
2.8	9142	2.58	508	11.0	EP310L4	--	100L2-4	OK	PAGE 150
2.8	9101	2.33	505	14.0	--	EP310R4	100L2-4	OK	PAGE 150
3.0	8532	1.21	474	7.5	EP307L4	--	100L2-4	OK	PAGE 130
3.0	8532	1.97	474	7.5	EP309L4	--	100L2-4	OK	PAGE 140
3.1	8126	1.15	451	6.0	EP306L4	--	100L2-4	OK	PAGE 120
3.2	7774	1.21	432	14.0	--	EP307R4	100L2-4	OK	PAGE 130
3.2	7774	2.12	432	14.0	--	EP309R4	100L2-4	OK	PAGE 140
3.3	7679	2.88	426	11.0	EP310L4	--	100L2-4	OK	PAGE 150
3.4	7437	2.82	413	14.0	--	EP310R4	100L2-4	OK	PAGE 150
3.8	6674	3.09	371	14.0	--	EP310R4	100L2-4	OK	PAGE 150
3.8	6573	1.52	365	7.5	EP307L4	--	100L2-4	OK	PAGE 130
3.8	6573	2.42	365	7.5	EP309L4	--	100L2-4	OK	PAGE 140
4.0	6229	1.52	346	14.0	--	EP307R4	100L2-4	OK	PAGE 130
4.0	6229	2.42	346	14.0	--	EP309R4	100L2-4	OK	PAGE 140
4.1	6188	1.48	344	6.0	EP306L4	--	100L2-4	OK	PAGE 120
4.1	6161	0.97	342	12.0	--	EP306R4	100L2-4	OK	PAGE 120
4.2	6138	2.78	330	18.0	EP310L3	--	100L2-4	OK	PAGE 150
4.3	5916	3.64	329	11.0	EP310L4	--	100L2-4	OK	PAGE 150
4.4	5730	0.88	318	6.0	EP305L4	--	100L2-4	OK	PAGE 110
4.5	5590	1.67	310	14.0	--	EP307R4	100L2-4	OK	PAGE 130
4.5	5590	2.73	310	14.0	--	EP309R4	100L2-4	OK	PAGE 140
4.6	5696	1.47	306	11.0	EP307L3	--	100L2-4	OK	PAGE 130
4.8	5261	1.45	292	12.0	--	EP306R4	100L2-4	OK	PAGE 120
4.9	5160	1.00	287	12.0	--	EP305R4	100L2-4	OK	PAGE 110
4.9	5289	1.23	284	7.5	EP306L3	--	100L2-4	OK	PAGE 120
5.0	5006	1.82	278	7.5	EP307L4	--	100L2-4	OK	PAGE 130
5.0	5006	3.03	278	7.5	EP309L4	--	100L2-4	OK	PAGE 140
5.0	4998	1.00	278	6.0	EP305L4	--	100L2-4	OK	PAGE 110
5.2	5008	3.37	269	18.0	EP310L3	--	100L2-4	OK	PAGE 150
5.3	4744	1.88	263	6.0	EP306L4	--	100L2-4	OK	PAGE 120
5.4	4685	1.82	260	14.0	--	EP307R4	100L2-4	OK	PAGE 130
5.4	4685	3.18	260	14.0	--	EP309R4	100L2-4	OK	PAGE 140
5.4	4799	2.05	258	11.0	EP307L3	--	100L2-4	OK	PAGE 130
5.4	4799	2.34	258	11.0	EP309L3	--	100L2-4	OK	PAGE 140
6.0	4322	1.49	232	7.5	EP306L3	--	100L2-4	OK	PAGE 120
6.3	3975	1.21	221	12.0	--	EP305R4	100L2-4	OK	PAGE 110
6.4	3936	2.12	219	14.0	--	EP307R4	100L2-4	OK	PAGE 130
6.6	3921	2.34	211	11.0	EP307L3	--	100L2-4	OK	PAGE 130
6.7	3748	2.27	208	12.0	--	EP306R4	100L2-4	OK	PAGE 120

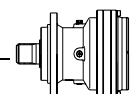

EP300 series gear motor

P1=3.0KW n1=1400 min⁻¹

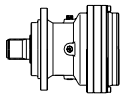
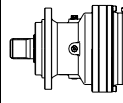
n₂ (min ⁻¹)	M₂ (N.m)	S	I 1:	P_t (KW)			IEC Motor type	Check Thermal Power Pt >= P1	Dimension Page Number
6.7	3867	1.11	208	7.5	EP305L3	--	100L2-4	OK	PAGE 110
6.9	3655	2.42	203	6.0	EP306L4	--	100L2-4	OK	PAGE 120
8.0	3249	1.47	174	7.5	EP305L3	--	100L2-4	OK	PAGE 110
8.3	3142	2.93	169	11.0	EP307L3	--	100L2-4	OK	PAGE 130
8.3	3032	2.73	168	14.0	--	EP307R4	100L2-4	OK	PAGE 130
8.3	3027	1.36	168	12.0	--	EP305R4	100L2-4	OK	PAGE 110
8.4	3108	2.02	167	7.5	EP306L3	--	100L2-4	OK	PAGE 120
8.7	2887	2.88	160	12.0	--	EP306R4	100L2-4	OK	PAGE 120
9.2	2820	3.46	151	11.0	EP307L3	--	100L2-4	OK	PAGE 130
9.5	2643	0.88	147	12.0	--	EP303R4	100L2-4	OK	PAGE 100
9.5	2643	1.52	147	12.0	--	EP305R4	100L2-4	OK	PAGE 110
9.8	2654	2.64	143	7.5	EP306L3	--	100L2-4	OK	PAGE 120
10.0	2603	0.94	140	7.5	EP303L3	--	100L2-4	OK	PAGE 100
10.0	2603	1.82	140	7.5	EP305L3	--	100L2-4	OK	PAGE 110
10.8	2332	0.97	130	12.0	--	EP303R4	100L2-4	OK	PAGE 100
10.8	2332	1.67	130	12.0	--	EP305R4	100L2-4	OK	PAGE 110
10.9	2309	3.33	128	14.0	--	EP307R4	100L2-4	OK	PAGE 130
11.5	2199	3.42	122	12.0	--	EP306R4	100L2-4	OK	PAGE 120
12.4	2036	1.09	113	12.0	--	EP303R4	100L2-4	OK	PAGE 100
12.4	2036	1.85	113	12.0	--	EP305R4	100L2-4	OK	PAGE 110
12.9	2027	3.52	109	20.0	--	EP307R3	100L2-4	OK	PAGE 130
13.0	2005	1.17	108	7.5	EP303L3	--	100L2-4	OK	PAGE 100
13.0	2005	2.05	108	7.5	EP305L3	--	100L2-4	OK	PAGE 110
13.8	1891	3.22	102	7.5	EP306L3	--	100L2-4	OK	PAGE 120
13.9	1874	0.88	101	14.0	--	EP303R3	100L2-4	OK	PAGE 100
13.9	1874	1.55	101	14.0	--	EP305R3	100L2-4	OK	PAGE 110
14.1	1846	2.64	99.1	14.0	--	EP306R3	100L2-4	OK	PAGE 120
14.2	1776	1.21	98.6	12.0	--	EP303R4	100L2-4	OK	PAGE 100
14.2	1776	2.12	98.6	12.0	--	EP305R4	100L2-4	OK	PAGE 110
15.9	1635	0.88	87.8	7.5	EP301L3	--	100L2-4	OK	PAGE 90
17.0	1531	1.08	82.2	14.0	--	EP303R3	100L2-4	OK	PAGE 100
17.0	1531	2.05	82.2	14.0	--	EP305R3	100L2-4	OK	PAGE 110
17.1	1527	1.47	82.0	7.5	EP303L3	--	100L2-4	OK	PAGE 100
17.1	1527	2.64	82.0	7.5	EP305L3	--	100L2-4	OK	PAGE 110
17.6	1431	1.06	79.5	10.0	--	EP301R4	100L2-4	OK	PAGE 90
19.0	1374	1.23	73.8	14.0	--	EP303R3	100L2-4	OK	PAGE 100
19.6	1333	1.61	71.6	7.5	EP303L3	--	100L2-4	OK	PAGE 100
19.6	1333	2.64	71.6	7.5	EP305L3	--	100L2-4	OK	PAGE 110
21.2	1231	1.11	66.1	7.5	EP301L3	--	100L2-4	OK	PAGE 90
21.2	1227	1.32	65.9	14.0	--	EP303R3	100L2-4	OK	PAGE 100
21.2	1227	2.64	65.9	14.0	--	EP305R3	100L2-4	OK	PAGE 110
21.3	1222	1.20	65.6	12.0	--	EP301R3	100L2-4	OK	PAGE 90
22.2	1176	1.82	63.2	7.5	EP303L3	--	100L2-4	OK	PAGE 100
22.2	1176	2.64	63.2	7.5	EP305L3	--	100L2-4	OK	PAGE 110
22.8	1145	1.64	61.5	14.0	--	EP303R3	100L2-4	OK	PAGE 100
22.8	1145	2.93	61.5	14.0	--	EP305R3	100L2-4	OK	PAGE 110
23.7	1101	1.41	59.1	14.0	--	EP303R3	100L2-4	OK	PAGE 100
23.7	1101	2.93	59.1	14.0	--	EP305R3	100L2-4	OK	PAGE 110
25.4	1027	2.05	55.2	7.5	EP303L3	--	100L2-4	OK	PAGE 100
25.4	1027	2.93	55.2	7.5	EP305L3	--	100L2-4	OK	PAGE 110
26.6	979	1.47	52.6	12.0	--	EP301R3	100L2-4	OK	PAGE 90

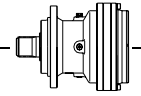

EP300 series gear motor

P1=3.0KW **n1=1400 min⁻¹**

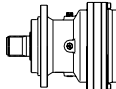
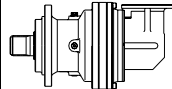
n₂ (min ⁻¹)	M₂ (N.m)	S	I 1:	P_t (KW)			IEC Motor type	Check Thermal Power Pt >= P1	Dimension Page Number
27.0	966	1.99	51.9	14.0	--	EP303R3	100L2-4	OK	PAGE 100
27.0	997	1.02	51.8	7.5	EP301L2	--	100L2-4	OK	PAGE 90
27.1	962	2.70	51.7	14.0	--	EP303R3	100L2-4	OK	PAGE 100
27.5	948	1.44	50.9	7.5	EP301L3	--	100L2-4	OK	PAGE 90
28.2	925	2.55	49.7	14.0	--	EP303R3	100L2-4	OK	PAGE 100
28.5	944	1.70	49.1	9.0	EP303L2	--	100L2-4	OK	PAGE 100
28.5	944	2.84	49.1	9.0	EP305L2	--	100L2-4	OK	PAGE 110
29.1	896	2.34	48.1	7.5	EP303L3	--	100L2-4	OK	PAGE 100
33.7	799	1.48	41.5	7.5	EP301L2	--	100L2-4	OK	PAGE 90
34.6	754	0.97	40.5	12.0	--	EP300R3	100L2-4	OK	PAGE 80
34.6	754	1.85	40.5	12.0	--	EP301R3	100L2-4	OK	PAGE 90
34.9	772	2.27	40.1	9.0	EP303L2	--	100L2-4	OK	PAGE 100
36.1	722	1.03	38.8	7.5	EP300L3	--	100L2-4	OK	PAGE 80
36.1	722	1.76	38.8	7.5	EP301L3	--	100L2-4	OK	PAGE 90
43.6	618	2.84	32.1	9.0	EP303L2	--	100L2-4	OK	PAGE 100
43.8	616	1.16	32.0	7.5	EP300L2	--	100L2-4	OK	PAGE 80
43.8	616	2.13	32.0	7.5	EP301L2	--	100L2-4	OK	PAGE 90
45.4	574	1.23	30.8	12.0	--	EP300R3	100L2-4	OK	PAGE 80
45.4	574	2.26	30.8	12.0	--	EP301R3	100L2-4	OK	PAGE 90
46.7	577	3.26	30.0	9.0	EP303L2	--	100L2-4	OK	PAGE 100
48.5	555	3.40	28.8	9.0	EP303L2	--	100L2-4	OK	PAGE 100
54.6	493	1.42	25.6	7.5	EP300L2	--	100L2-4	OK	PAGE 80
54.6	493	2.33	25.6	7.5	EP301L2	--	100L2-4	OK	PAGE 90
59.6	437	1.47	23.5	12.0	--	EP300R3	100L2-4	OK	PAGE 80
59.6	437	2.34	23.5	12.0	--	EP301R3	100L2-4	OK	PAGE 90
70.9	380	1.76	19.8	7.5	EP300L2	--	100L2-4	OK	PAGE 80
70.9	380	2.84	19.8	7.5	EP301L2	--	100L2-4	OK	PAGE 90
93.1	289	2.13	15.0	7.5	EP300L2	--	100L2-4	OK	PAGE 80
93.1	289	3.40	15.0	7.5	EP301L2	--	100L2-4	OK	PAGE 90
94.9	284	1.42	14.8	12.0	--	EP300R2	100L2-4	OK	PAGE 80
94.9	284	3.12	14.8	12.0	--	EP301R2	100L2-4	OK	PAGE 90
118	227	2.13	11.8	12.0	--	EP300R2	100L2-4	OK	PAGE 80
122	220	2.55	11.5	7.5	EP300L2	--	100L2-4	OK	PAGE 80
194	143	3.02	7.2	7.5	EP300L1	--	100L2-4	OK	PAGE 80
194	143	3.02	7.2	7.5	EP300L1	--	100L2-4	OK	PAGE 80

EP300 series gear motor

P1=4.0KW **n1=1400 min⁻¹**

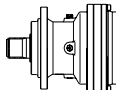
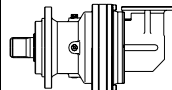
n₂ (min ⁻¹)	M₂ (N.m)	S	I 1:	P_t (KW)			IEC Motor type	Check Thermal Power Pt >= P1	Dimension Page Number
0.7	49312	1.59	2054	18.0	EP315L4	--	112M-4	OK	PAGE 180
0.75	44627	1.02	1859	11.0	EP313L4	--	112M-4	OK	PAGE 170
0.8	41550	2.05	1731	18.0	EP315L4	--	112M-4	OK	PAGE 180
0.87	38554	0.98	1606	11.0	EP311L4	--	112M-4	OK	PAGE 160
0.89	37636	1.30	1568	11.0	EP313L4	--	112M-4	OK	PAGE 170
1.0	33902	2.39	1412	18.0	EP315L4	--	112M-4	OK	PAGE 180

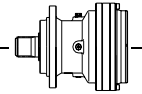

EP300 series gear motor

P1=4.0KW n1=1400 min⁻¹

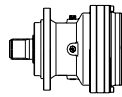
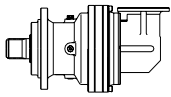
n₂ (min ⁻¹)	M₂ (N.m)	S	I i:	P_t (KW)			IEC Motor type	Check Thermal Power Pt >= P1	Dimension Page Number
1.0	33364	3.52	1390	18.0	EP316L4	--	112M-4	OK	PAGE 190
1.0	32486	1.14	1353	11.0	EP311L4	--	112M-4	OK	PAGE 160
1.1	31712	1.52	1321	11.0	EP313L4	--	112M-4	OK	PAGE 170
1.1	29506	2.39	1229	18.0	EP315L4	--	112M-4	OK	PAGE 180
1.2	27861	0.86	1160	11.0	EP310L4	--	112M-4	OK	PAGE 150
1.3	26545	1.36	1106	11.0	EP311L4	--	112M-4	OK	PAGE 160
1.3	25913	1.82	1079	11.0	EP313L4	--	112M-4	OK	PAGE 170
1.4	24862	3.18	1036	18.0	EP315L4	--	112M-4	OK	PAGE 180
1.5	22325	1.00	930	11.0	EP310L4	--	112M-4	OK	PAGE 150
1.6	21270	1.66	886	11.0	EP311L4	--	112M-4	OK	PAGE 160
1.6	20764	2.05	865	11.0	EP313L4	--	112M-4	OK	PAGE 170
1.7	20280	0.98	845	14.0	--	EP310R4	112M-4	OK	PAGE 150
1.7	20035	1.09	834	11.0	EP310L4	--	112M-4	OK	PAGE 150
1.8	19089	1.82	795	11.0	EP311L4	--	112M-4	OK	PAGE 160
1.8	18634	2.27	776	11.0	EP313L4	--	112M-4	OK	PAGE 170
1.8	18430	1.02	768	7.5	EP309L4	--	112M-4	OK	PAGE 140
2.0	17110	1.27	713	11.0	EP310L4	--	112M-4	OK	PAGE 150
2.0	16547	1.14	689	14.0	--	EP310R4	112M-4	OK	PAGE 150
2.1	15998	2.16	666	11.0	EP311L4	--	112M-4	OK	PAGE 160
2.1	15883	2.50	662	22.0	--	EP313R4	112M-4	OK	PAGE 170
2.2	15617	2.84	650	11.0	EP313L4	--	112M-4	OK	PAGE 170
2.2	15055	0.91	627	14.0	--	EP309R4	112M-4	OK	PAGE 140
2.3	14511	1.48	604	11.0	EP310L4	--	112M-4	OK	PAGE 150
2.4	14198	1.25	591	7.5	EP309L4	--	112M-4	OK	PAGE 140
2.5	13522	1.36	563	14.0	--	EP310R4	112M-4	OK	PAGE 150
2.5	13439	2.55	560	11.0	EP311L4	--	112M-4	OK	PAGE 160
2.5	13395	3.41	558	22.0	--	EP313R4	112M-4	OK	PAGE 170
2.6	13119	3.41	546	11.0	EP313L4	--	112M-4	OK	PAGE 170
2.6	13028	2.16	543	22.0	--	EP311R4	112M-4	OK	PAGE 160
2.6	12685	1.02	528	14.0	--	EP309R4	112M-4	OK	PAGE 140
2.8	12189	1.93	508	11.0	EP310L4	--	112M-4	OK	PAGE 150
2.8	12135	1.75	505	14.0	--	EP310R4	112M-4	OK	PAGE 150
3.0	11377	0.91	474	7.5	EP307L4	--	112M-4	OK	PAGE 130
3.0	11377	1.48	474	7.5	EP309L4	--	112M-4	OK	PAGE 140
3.1	10977	3.02	457	22.0	--	EP311R4	112M-4	OK	PAGE 160
3.1	10835	0.86	451	6.0	EP306L4	--	112M-4	OK	PAGE 120
3.2	10472	3.18	436	11.0	EP311L4	--	112M-4	OK	PAGE 160
3.2	10365	0.91	432	14.0	--	EP307R4	112M-4	OK	PAGE 130
3.2	10365	1.59	432	14.0	--	EP309R4	112M-4	OK	PAGE 140
3.3	10239	2.16	426	11.0	EP310L4	--	112M-4	OK	PAGE 150
3.4	9916	2.11	413	14.0	--	EP310R4	112M-4	OK	PAGE 150
3.6	9249	3.52	385	22.0	--	EP311R4	112M-4	OK	PAGE 160
3.8	8899	2.32	371	14.0	--	EP310R4	112M-4	OK	PAGE 150
3.8	8764	1.14	365	7.5	EP307L4	--	112M-4	OK	PAGE 130
3.8	8764	1.82	365	7.5	EP309L4	--	112M-4	OK	PAGE 140
4.0	8306	1.14	346	14.0	--	EP307R4	112M-4	OK	PAGE 130
4.0	8306	1.82	346	14.0	--	EP309R4	112M-4	OK	PAGE 140
4.1	8251	1.11	344	6.0	EP306L4	--	112M-4	OK	PAGE 120
4.2	8184	2.09	330	18.0	EP310L3	--	112M-4	OK	PAGE 150
4.3	7888	2.73	329	11.0	EP310L4	--	112M-4	OK	PAGE 150
4.4	7600	2.61	317	14.0	--	EP310R4	112M-4	OK	PAGE 150

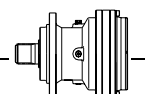

EP300 series gear motor

P1=4.0KW n1=1400 min⁻¹

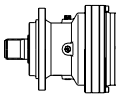
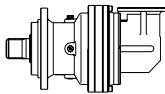
n₂ (min ⁻¹)	M₂ (N.m)	S	I I:	P_t (KW)			IEC Motor type	Check Thermal Power Pt >= P1	Dimension Page Number
4.5	7454	1.25	310	14.0	--	EP307R4	112M-4	OK	PAGE 130
4.5	7454	2.05	310	14.0	--	EP309R4	112M-4	OK	PAGE 140
4.6	7594	1.10	306	11.0	EP307L3	--	112M-4	OK	PAGE 130
4.8	7015	1.09	292	12.0	--	EP306R4	112M-4	OK	PAGE 120
4.9	7052	0.92	284	7.5	EP306L3	--	112M-4	OK	PAGE 120
5.0	6674	1.36	278	7.5	EP307L4	--	112M-4	OK	PAGE 130
5.0	6674	2.27	278	7.5	EP309L4	--	112M-4	OK	PAGE 140
5.2	6678	2.53	269	18.0	EP310L3	--	112M-4	OK	PAGE 150
5.2	6445	2.95	268	14.0	--	EP310R4	112M-4	OK	PAGE 150
5.3	6572	3.52	265	18.0	EP311L3	--	112M-4	OK	PAGE 160
5.3	6326	1.41	263	6.0	EP306L4	--	112M-4	OK	PAGE 120
5.4	6247	1.36	260	14.0	--	EP307R4	112M-4	OK	PAGE 130
5.4	6247	2.39	260	14.0	--	EP309R4	112M-4	OK	PAGE 140
5.4	6399	1.54	258	11.0	EP307L3	--	112M-4	OK	PAGE 130
5.4	6399	1.76	258	11.0	EP309L3	--	112M-4	OK	PAGE 140
6.0	5762	1.12	232	7.5	EP306L3	--	112M-4	OK	PAGE 120
6.2	5414	3.41	226	14.0	--	EP310R4	112M-4	OK	PAGE 150
6.3	5300	0.91	221	12.0	--	EP305R4	112M-4	OK	PAGE 110
6.4	5457	3.08	220	18.0	EP310L3	--	112M-4	OK	PAGE 150
6.4	5247	1.59	219	14.0	--	EP307R4	112M-4	OK	PAGE 130
6.4	5247	2.73	219	14.0	--	EP309R4	112M-4	OK	PAGE 140
6.6	5229	1.76	211	11.0	EP307L3	--	112M-4	OK	PAGE 130
6.6	5229	2.86	211	11.0	EP309L3	--	112M-4	OK	PAGE 140
6.7	4998	1.70	208	12.0	--	EP306R4	112M-4	OK	PAGE 120
6.9	4873	1.82	203	6.0	EP306L4	--	112M-4	OK	PAGE 120
8.0	4331	1.10	174	7.5	EP305L3	--	112M-4	OK	PAGE 110
8.3	4190	2.20	169	11.0	EP307L3	--	112M-4	OK	PAGE 130
8.3	4190	3.52	169	11.0	EP309L3	--	112M-4	OK	PAGE 140
8.3	4042	2.05	168	14.0	--	EP307R4	112M-4	OK	PAGE 130
8.3	4042	3.41	168	14.0	--	EP309R4	112M-4	OK	PAGE 140
8.3	4036	1.02	168	12.0	--	EP305R4	112M-4	OK	PAGE 110
8.4	4144	1.52	167	7.5	EP306L3	--	112M-4	OK	PAGE 120
8.7	3850	2.16	160	12.0	--	EP306R4	112M-4	OK	PAGE 120
9.2	3760	2.59	151	11.0	EP307L3	--	112M-4	OK	PAGE 130
9.5	3524	1.14	147	12.0	--	EP305R4	112M-4	OK	PAGE 110
9.8	3539	1.98	143	7.5	EP306L3	--	112M-4	OK	PAGE 120
10.0	3471	1.36	140	7.5	EP305L3	--	112M-4	OK	PAGE 110
10.8	3110	1.25	130	12.0	--	EP305R4	112M-4	OK	PAGE 110
10.9	3078	2.50	128	14.0	--	EP307R4	112M-4	OK	PAGE 130
10.9	3078	3.52	128	14.0	--	EP309R4	112M-4	OK	PAGE 140
11.0	3151	3.08	127	11.0	EP307L3	--	112M-4	OK	PAGE 130
11.5	2932	2.57	122	12.0	--	EP306R4	112M-4	OK	PAGE 120
12.4	2715	1.39	113	12.0	--	EP305R4	112M-4	OK	PAGE 110
12.5	2688	2.73	112	14.0	--	EP307R4	112M-4	OK	PAGE 130
12.9	2703	2.64	109	20.0	--	EP307R3	112M-4	OK	PAGE 130
12.9	2703	3.52	109	20.0	--	EP309R3	112M-4	OK	PAGE 140
13.0	2674	0.88	108	7.5	EP303L3	--	112M-4	OK	PAGE 100
13.0	2674	1.54	108	7.5	EP305L3	--	112M-4	OK	PAGE 110
13.1	2647	3.52	107	11.0	EP307L3	--	112M-4	OK	PAGE 130
13.8	2521	2.42	102	7.5	EP306L3	--	112M-4	OK	PAGE 120
13.9	2499	1.16	101	14.0	--	EP305R3	112M-4	OK	PAGE 110

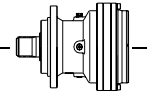

EP300 series gear motor

P1=4.0KW n1=1400 min⁻¹

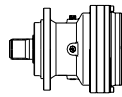
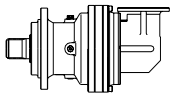
n₂ (min ⁻¹)	M₂ (N.m)	S	I i:	P_t (KW)			IEC Motor type	Check Thermal Power Pt >= P1	Dimension Page Number
14.1	2461	1.98	99.1	14.0	--	EP306R3	112M-4	OK	PAGE 120
14.2	2368	0.91	98.6	12.0	--	EP303R4	112M-4	OK	PAGE 100
14.2	2368	1.59	98.6	12.0	--	EP305R4	112M-4	OK	PAGE 110
15.0	2248	3.18	93.6	12.0	--	EP306R4	112M-4	OK	PAGE 120
15.3	2277	3.30	91.7	20.0	--	EP307R3	112M-4	OK	PAGE 130
17.0	2042	1.54	82.2	14.0	--	EP305R3	112M-4	OK	PAGE 110
17.1	2036	1.10	82.0	7.5	EP303L3	--	112M-4	OK	PAGE 100
17.1	2036	1.98	82.0	7.5	EP305L3	--	112M-4	OK	PAGE 110
17.3	2008	2.86	80.9	14.0	--	EP306R3	112M-4	OK	PAGE 120
17.9	1942	2.86	78.2	7.5	EP306L3	--	112M-4	OK	PAGE 120
19.0	1832	0.92	73.8	14.0	--	EP303R3	112M-4	OK	PAGE 100
19.6	1778	1.21	71.6	7.5	EP303L3	--	112M-4	OK	PAGE 100
19.6	1778	1.98	71.6	7.5	EP305L3	--	112M-4	OK	PAGE 110
21.2	1641	3.30	66.1	14.0	--	EP306R3	112M-4	OK	PAGE 120
21.2	1636	0.99	65.9	14.0	--	EP303R3	112M-4	OK	PAGE 100
21.2	1636	1.98	65.9	14.0	--	EP305R3	112M-4	OK	PAGE 110
21.3	1629	0.90	65.6	12.0	--	EP301R3	112M-4	OK	PAGE 90
22.2	1569	1.36	63.2	7.5	EP303L3	--	112M-4	OK	PAGE 100
22.2	1569	1.98	63.2	7.5	EP305L3	--	112M-4	OK	PAGE 110
22.8	1527	1.23	61.5	14.0	--	EP303R3	112M-4	OK	PAGE 100
22.8	1527	2.20	61.5	14.0	--	EP305R3	112M-4	OK	PAGE 110
23.7	1468	1.05	59.1	14.0	--	EP303R3	112M-4	OK	PAGE 100
23.7	1468	2.20	59.1	14.0	--	EP305R3	112M-4	OK	PAGE 110
25.4	1369	1.54	55.2	7.5	EP303L3	--	112M-4	OK	PAGE 100
25.4	1369	2.20	55.2	7.5	EP305L3	--	112M-4	OK	PAGE 110
26.6	1305	1.10	52.6	12.0	--	EP301R3	112M-4	OK	PAGE 90
27.0	1288	1.49	51.9	14.0	--	EP303R3	112M-4	OK	PAGE 100
27.1	1283	2.02	51.7	14.0	--	EP303R3	112M-4	OK	PAGE 100
27.1	1283	2.64	51.7	14.0	--	EP305R3	112M-4	OK	PAGE 110
27.5	1264	1.08	50.9	7.5	EP301L3	--	112M-4	OK	PAGE 90
28.2	1233	1.91	49.7	14.0	--	EP303R3	112M-4	OK	PAGE 100
28.2	1233	2.64	49.7	14.0	--	EP305R3	112M-4	OK	PAGE 110
28.5	1259	1.28	49.1	9.0	EP303L2	--	112M-4	OK	PAGE 100
28.5	1259	2.13	49.1	9.0	EP305L2	--	112M-4	OK	PAGE 110
29.0	1240	3.40	48.3	13.0	EP306L2	--	112M-4	OK	PAGE 120
29.1	1195	1.76	48.1	7.5	EP303L3	--	112M-4	OK	PAGE 100
29.1	1195	2.64	48.1	7.5	EP305L3	--	112M-4	OK	PAGE 110
33.7	1065	1.11	41.5	7.5	EP301L2	--	112M-4	OK	PAGE 90
34.6	1005	1.38	40.5	12.0	--	EP301R3	112M-4	OK	PAGE 90
34.9	1029	1.70	40.1	9.0	EP303L2	--	112M-4	OK	PAGE 100
34.9	1029	3.19	40.1	9.0	EP305L2	--	112M-4	OK	PAGE 110
36.1	963	1.32	38.8	7.5	EP301L3	--	112M-4	OK	PAGE 90
36.6	950	2.73	38.3	14.0	--	EP303R3	112M-4	OK	PAGE 100
36.6	950	3.08	38.3	14.0	--	EP305R3	112M-4	OK	PAGE 110
43.6	824	2.13	32.1	9.0	EP303L2	--	112M-4	OK	PAGE 100
43.8	821	0.87	32.0	7.5	EP300L2	--	112M-4	OK	PAGE 80
43.8	821	1.60	32.0	7.5	EP301L2	--	112M-4	OK	PAGE 90
45.4	766	0.92	30.8	12.0	--	EP300R3	112M-4	OK	PAGE 80
45.4	766	1.69	30.8	12.0	--	EP301R3	112M-4	OK	PAGE 90
46.7	769	2.45	30.0	9.0	EP303L2	--	112M-4	OK	PAGE 100
48.0	724	3.30	29.1	14.0	--	EP305R3	112M-4	OK	PAGE 110

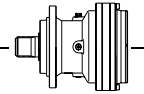

EP300 series gear motor

P1=4.0KW **n1=1400 min⁻¹**

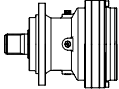
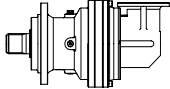
n₂ (min ⁻¹)	M₂ (N.m)	S	I 1:	P_t (KW)			IEC Motor type	Check Thermal Power Pt >= P1	Dimension Page Number
48.0	724	3.36	29.1	14.0	--	EP303R3	112M-4	OK	PAGE 100
54.6	658	1.06	25.6	7.5	EP300L2	--	112M-4	OK	PAGE 80
54.6	658	1.74	25.6	7.5	EP301L2	--	112M-4	OK	PAGE 90
55.0	632	2.86	25.4	14.0	--	EP305R3	112M-4	OK	PAGE 110
55.0	632	3.14	25.4	14.0	--	EP303R3	112M-4	OK	PAGE 100
55.6	646	2.77	25.2	9.0	EP303L2	--	112M-4	OK	PAGE 100
57.8	621	2.77	24.2	9.0	EP303L2	--	112M-4	OK	PAGE 100
59.6	583	1.10	23.5	12.0	--	EP300R3	112M-4	OK	PAGE 80
59.6	583	1.76	23.5	12.0	--	EP301R3	112M-4	OK	PAGE 90
70.9	507	1.32	19.8	7.5	EP300L2	--	112M-4	OK	PAGE 80
70.9	507	2.13	19.8	7.5	EP301L2	--	112M-4	OK	PAGE 90
80.1	448	3.04	17.5	18.0	--	EP303R2	112M-4	OK	PAGE 100
80.1	448	3.04	17.5	18.0	--	EP305R2	112M-4	OK	PAGE 110
93.1	386	1.60	15.0	7.5	EP300L2	--	112M-4	OK	PAGE 80
93.1	386	2.55	15.0	7.5	EP301L2	--	112M-4	OK	PAGE 90
94.9	379	1.06	14.8	12.0	--	EP300R2	112M-4	OK	PAGE 80
94.9	379	2.34	14.8	12.0	--	EP301R2	112M-4	OK	PAGE 90
118	303	1.60	11.8	12.0	--	EP300R2	112M-4	OK	PAGE 80
118	303	2.98	11.8	12.0	--	EP301R2	112M-4	OK	PAGE 90
122	294	1.91	11.5	7.5	EP300L2	--	112M-4	OK	PAGE 80
122	294	3.19	11.5	7.5	EP301L2	--	112M-4	OK	PAGE 90
154	234	3.19	9.1	12.0	--	EP300R2	112M-4	OK	PAGE 80
154	234	3.19	9.1	12.0	--	EP301R2	112M-4	OK	PAGE 90
194	191	2.27	7.2	7.5	EP300L1	--	112M-4	OK	PAGE 80
194	191	2.27	7.2	7.5	EP300L1	--	112M-4	OK	PAGE 80
202	178	3.19	6.9	12.0	--	EP300R2	112M-4	OK	PAGE 80
202	178	3.19	6.9	12.0	--	EP301R2	112M-4	OK	PAGE 90
243	153	3.09	5.8	7.5	EP300L1	--	112M-4	OK	PAGE 80

EP300 series gear motor

P1=5.5KW **n1=1400 min⁻¹**

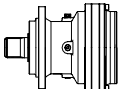
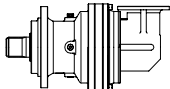
n₂ (min ⁻¹)	M₂ (N.m)	S	I 1:	P_t (KW)			IEC Motor type	Check Thermal Power Pt >= P1	Dimension Page Number
0.7	67804	1.16	2054	18.0	EP315L4	--	132S-4	OK	PAGE 180
0.8	57131	1.49	1731	18.0	EP315L4	--	132S-4	OK	PAGE 180
0.89	51750	0.94	1568	11.0	EP313L4	--	132S-4	OK	PAGE 170
1.0	46615	1.74	1412	18.0	EP315L4	--	132S-4	OK	PAGE 180
1.0	45876	2.56	1390	18.0	EP316L4	--	132S-4	OK	PAGE 190
1.1	43604	1.11	1321	11.0	EP313L4	--	132S-4	OK	PAGE 170
1.1	40571	1.74	1229	18.0	EP315L4	--	132S-4	OK	PAGE 180
1.2	38655	2.98	1171	18.0	EP316L4	--	132S-4	OK	PAGE 190
1.3	36500	0.99	1106	11.0	EP311L4	--	132S-4	OK	PAGE 160
1.3	35631	1.32	1079	11.0	EP313L4	--	132S-4	OK	PAGE 170
1.4	34185	2.31	1036	18.0	EP315L4	--	132S-4	OK	PAGE 180
1.6	29247	1.21	886	11.0	EP311L4	--	132S-4	OK	PAGE 160
1.6	28650	2.89	868	18.0	EP315L4	--	132S-4	OK	PAGE 180

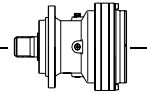

EP300 series gear motor

P1=5.5KW n1=1400 min⁻¹

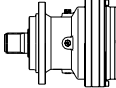
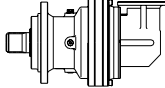
n₂ (min ⁻¹)	M₂ (N.m)	S	I I:	P_t (KW)			IEC Motor type	Check Thermal Power Pt >= P1	Dimension Page Number
1.6	28550	1.49	865	11.0	EP313L4	--	132S-4	OK	PAGE 170
1.8	26247	1.32	795	11.0	EP311L4	--	132S-4	OK	PAGE 160
1.8	25622	1.65	776	11.0	EP313L4	--	132S-4	OK	PAGE 170
1.8	25483	2.64	772	40.0	--	EP315R4	132S-4	OK	PAGE 180
2.0	23527	0.93	713	11.0	EP310L4	--	132S-4	OK	PAGE 150
2.1	21998	1.57	666	11.0	EP311L4	--	132S-4	OK	PAGE 160
2.1	21839	1.82	662	22.0	--	EP313R4	132S-4	OK	PAGE 170
2.2	21474	2.07	650	11.0	EP313L4	--	132S-4	OK	PAGE 170
2.2	21472	3.47	650	40.0	--	EP315R4	132S-4	OK	PAGE 180
2.3	19952	1.07	604	11.0	EP310L4	--	132S-4	OK	PAGE 150
2.4	19522	0.91	591	7.5	EP309L4	--	132S-4	OK	PAGE 140
2.5	18592	0.99	563	14.0	--	EP310R4	132S-4	OK	PAGE 150
2.5	18478	1.85	560	11.0	EP311L4	--	132S-4	OK	PAGE 160
2.5	18418	2.48	558	22.0	--	EP313R4	132S-4	OK	PAGE 170
2.6	18038	2.48	546	11.0	EP313L4	--	132S-4	OK	PAGE 170
2.6	17914	1.57	543	22.0	--	EP311R4	132S-4	OK	PAGE 160
2.8	16760	1.40	508	11.0	EP310L4	--	132S-4	OK	PAGE 150
2.8	16685	1.27	505	14.0	--	EP310R4	132S-4	OK	PAGE 150
3.0	15643	1.07	474	7.5	EP309L4	--	132S-4	OK	PAGE 140
3.0	15519	2.89	470	22.0	--	EP313R4	132S-4	OK	PAGE 170
3.1	15094	2.20	457	22.0	--	EP311R4	132S-4	OK	PAGE 160
3.2	14398	2.31	436	11.0	EP311L4	--	132S-4	OK	PAGE 160
3.2	14252	1.16	432	14.0	--	EP309R4	132S-4	OK	PAGE 140
3.3	14078	1.57	426	11.0	EP310L4	--	132S-4	OK	PAGE 150
3.3	14078	3.64	426	11.0	EP313L4	--	132S-4	OK	PAGE 170
3.4	13634	1.54	413	14.0	--	EP310R4	132S-4	OK	PAGE 150
3.6	12718	2.56	385	22.0	--	EP311R4	132S-4	OK	PAGE 160
3.6	12681	3.47	384	22.0	--	EP313R4	132S-4	OK	PAGE 170
3.8	12236	1.69	371	14.0	--	EP310R4	132S-4	OK	PAGE 150
3.8	12051	1.32	365	7.5	EP309L4	--	132S-4	OK	PAGE 140
4.0	11420	1.32	346	14.0	--	EP309R4	132S-4	OK	PAGE 140
4.2	11092	2.98	336	11.0	EP311L4	--	132S-4	OK	PAGE 160
4.2	11253	1.52	330	18.0	EP310L3	--	132S-4	OK	PAGE 150
4.3	10846	1.98	329	11.0	EP310L4	--	132S-4	OK	PAGE 150
4.4	10450	1.90	317	14.0	--	EP310R4	132S-4	OK	PAGE 150
4.4	10392	3.07	315	22.0	--	EP311R4	132S-4	OK	PAGE 160
4.5	10249	0.91	310	14.0	--	EP307R4	132S-4	OK	PAGE 130
4.5	10249	1.49	310	14.0	--	EP309R4	132S-4	OK	PAGE 140
4.9	9464	3.47	287	11.0	EP311L4	--	132S-4	OK	PAGE 160
5.0	9326	3.39	283	22.0	--	EP311R4	132S-4	OK	PAGE 160
5.0	9177	0.99	278	7.5	EP307L4	--	132S-4	OK	PAGE 130
5.0	9177	1.65	278	7.5	EP309L4	--	132S-4	OK	PAGE 140
5.2	9182	1.84	269	18.0	EP310L3	--	132S-4	OK	PAGE 150
5.2	8862	2.15	268	14.0	--	EP310R4	132S-4	OK	PAGE 150
5.3	9036	2.56	265	18.0	EP311L3	--	132S-4	OK	PAGE 160
5.3	8698	1.02	263	6.0	EP306L4	--	132S-4	OK	PAGE 120
5.4	8590	0.99	260	14.0	--	EP307R4	132S-4	OK	PAGE 130
5.4	8590	1.74	260	14.0	--	EP309R4	132S-4	OK	PAGE 140
5.4	8798	1.12	258	11.0	EP307L3	--	132S-4	OK	PAGE 130
5.4	8798	1.28	258	11.0	EP309L3	--	132S-4	OK	PAGE 140
6.2	7444	2.48	226	14.0	--	EP310R4	132S-4	OK	PAGE 150

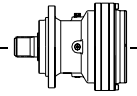

EP300 series gear motor

P1=5.5KW n1=1400 min⁻¹

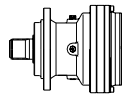
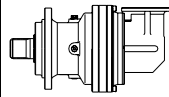
n₂ (min ⁻¹)	M₂ (N.m)	S	I I:	P_t (KW)			IEC Motor type	Check Thermal Power Pt >= P1	Dimension Page Number
6.3	7614	3.52	223	18.0	EP311L3	--	132S-4	OK	PAGE 160
6.4	7503	2.24	220	18.0	EP310L3	--	132S-4	OK	PAGE 150
6.4	7215	1.16	219	14.0	--	EP307R4	132S-4	OK	PAGE 130
6.4	7215	1.98	219	14.0	--	EP309R4	132S-4	OK	PAGE 140
6.6	7189	1.28	211	11.0	EP307L3	--	132S-4	OK	PAGE 130
6.6	7189	2.08	211	11.0	EP309L3	--	132S-4	OK	PAGE 140
6.7	6872	1.24	208	12.0	--	EP306R4	132S-4	OK	PAGE 120
6.9	6701	1.32	203	6.0	EP306L4	--	132S-4	OK	PAGE 120
7.1	6733	3.04	197	18.0	EP310L3	--	132S-4	OK	PAGE 150
7.4	6253	2.81	189	14.0	--	EP310R4	132S-4	OK	PAGE 150
8.3	5761	1.60	169	11.0	EP307L3	--	132S-4	OK	PAGE 130
8.3	5761	2.56	169	11.0	EP309L3	--	132S-4	OK	PAGE 140
8.3	5558	1.49	168	14.0	--	EP307R4	132S-4	OK	PAGE 130
8.3	5558	2.48	168	14.0	--	EP309R4	132S-4	OK	PAGE 140
8.4	5697	1.10	167	7.5	EP306L3	--	132S-4	OK	PAGE 120
8.7	5502	3.52	161	18.0	EP310L3	--	132S-4	OK	PAGE 150
8.7	5294	1.57	160	12.0	--	EP306R4	132S-4	OK	PAGE 120
9.2	5170	1.89	151	11.0	EP307L3	--	132S-4	OK	PAGE 130
9.2	5170	2.72	151	11.0	EP309L3	--	132S-4	OK	PAGE 140
9.6	4794	3.47	145	14.0	--	EP310R4	132S-4	OK	PAGE 150
9.8	4866	1.44	143	7.5	EP306L3	--	132S-4	OK	PAGE 120
10.0	4772	0.99	140	7.5	EP305L3	--	132S-4	OK	PAGE 110
10.9	4233	1.82	128	14.0	--	EP307R4	132S-4	OK	PAGE 130
10.9	4233	2.56	128	14.0	--	EP309R4	132S-4	OK	PAGE 140
11.0	4333	2.24	127	11.0	EP307L3	--	132S-4	OK	PAGE 130
11.0	4333	3.20	127	11.0	EP309L3	--	132S-4	OK	PAGE 140
11.3	4229	3.20	124	20.0	--	EP310R3	132S-4	OK	PAGE 150
11.5	4031	1.87	122	12.0	--	EP306R4	132S-4	OK	PAGE 120
12.4	3733	1.01	113	12.0	--	EP305R4	132S-4	OK	PAGE 110
12.5	3695	1.98	112	14.0	--	EP307R4	132S-4	OK	PAGE 130
12.9	3716	1.92	109	20.0	--	EP307R3	132S-4	OK	PAGE 130
12.9	3716	2.56	109	20.0	--	EP309R3	132S-4	OK	PAGE 140
13.0	3676	1.12	108	7.5	EP305L3	--	132S-4	OK	PAGE 110
13.1	3640	2.56	107	11.0	EP307L3	--	132S-4	OK	PAGE 130
13.8	3466	1.76	102	7.5	EP306L3	--	132S-4	OK	PAGE 120
13.9	3435	0.85	101	14.0	--	EP305R3	132S-4	OK	PAGE 110
14.1	3383	1.44	99.1	14.0	--	EP306R3	132S-4	OK	PAGE 120
14.2	3256	1.16	98.6	12.0	--	EP305R4	132S-4	OK	PAGE 110
15.0	3091	2.31	93.6	12.0	--	EP306R4	132S-4	OK	PAGE 120
15.3	3131	2.40	91.7	20.0	--	EP307R3	132S-4	OK	PAGE 130
15.3	3131	2.88	91.7	20.0	--	EP309R3	132S-4	OK	PAGE 140
17.0	2807	1.12	82.2	14.0	--	EP305R3	132S-4	OK	PAGE 110
17.0	2804	3.20	82.1	11.0	EP307L3	--	132S-4	OK	PAGE 130
17.1	2800	1.44	82.0	7.5	EP305L3	--	132S-4	OK	PAGE 110
17.3	2761	2.08	80.9	14.0	--	EP306R3	132S-4	OK	PAGE 120
17.9	2670	2.08	78.2	7.5	EP306L3	--	132S-4	OK	PAGE 120
18.7	2559	2.88	75.0	20.0	--	EP307R3	132S-4	OK	PAGE 130
18.7	2559	3.20	75.0	20.0	--	EP309R3	132S-4	OK	PAGE 140
19.6	2444	0.88	71.6	7.5	EP303L3	--	132S-4	OK	PAGE 100
19.6	2444	1.44	71.6	7.5	EP305L3	--	132S-4	OK	PAGE 110
20.8	2296	3.20	67.3	20.0	--	EP307R3	132S-4	OK	PAGE 130

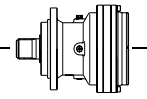

EP300 series gear motor

P1=5.5KW n1=1400 min⁻¹

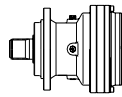
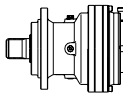
n₂ (min ⁻¹)	M₂ (N.m)	S	I i:	P_t (KW)			IEC Motor type	Check Thermal Power Pt >= P1	Dimension Page Number
20.8	2296	3.52	67.3	20.0	--	EP309R3	132S-4	OK	PAGE 140
21.2	2256	2.40	66.1	14.0	--	EP306R3	132S-4	OK	PAGE 120
21.2	2249	1.44	65.9	14.0	--	EP305R3	132S-4	OK	PAGE 110
22.2	2157	0.99	63.2	7.5	EP303L3	--	132S-4	OK	PAGE 100
22.2	2157	1.44	63.2	7.5	EP305L3	--	132S-4	OK	PAGE 110
22.8	2099	0.90	61.5	14.0	--	EP303R3	132S-4	OK	PAGE 100
22.8	2099	1.60	61.5	14.0	--	EP305R3	132S-4	OK	PAGE 110
23.5	2034	2.64	59.6	7.5	EP306L3	--	132S-4	OK	PAGE 120
23.6	2024	2.64	59.3	14.0	--	EP306R3	132S-4	OK	PAGE 120
23.7	2019	1.60	59.1	14.0	--	EP305R3	132S-4	OK	PAGE 110
24.8	1925	3.20	56.4	20.0	--	EP309R3	132S-4	OK	PAGE 140
24.8	1925	3.52	56.4	20.0	--	EP307R3	132S-4	OK	PAGE 130
25.4	1883	1.12	55.2	7.5	EP303L3	--	132S-4	OK	PAGE 100
25.4	1883	1.60	55.2	7.5	EP305L3	--	132S-4	OK	PAGE 110
27.0	1771	1.09	51.9	14.0	--	EP303R3	132S-4	OK	PAGE 100
27.1	1764	1.47	51.7	14.0	--	EP303R3	132S-4	OK	PAGE 100
27.1	1764	1.92	51.7	14.0	--	EP305R3	132S-4	OK	PAGE 110
27.6	1729	3.04	50.6	14.0	--	EP306R3	132S-4	OK	PAGE 120
28.2	1696	1.39	49.7	14.0	--	EP303R3	132S-4	OK	PAGE 100
28.2	1696	1.92	49.7	14.0	--	EP305R3	132S-4	OK	PAGE 110
28.5	1731	0.93	49.1	9.0	EP303L2	--	132S-4	OK	PAGE 100
28.5	1731	1.55	49.1	9.0	EP305L2	--	132S-4	OK	PAGE 110
29.0	1705	2.48	48.3	13.0	EP306L2	--	132S-4	OK	PAGE 120
29.1	1642	1.28	48.1	7.5	EP303L3	--	132S-4	OK	PAGE 100
29.1	1642	1.92	48.1	7.5	EP305L3	--	132S-4	OK	PAGE 110
29.6	1617	3.20	47.4	20.0	--	EP309R3	132S-4	OK	PAGE 140
30.7	1559	3.36	45.7	7.5	EP306L3	--	132S-4	OK	PAGE 120
33.9	1411	3.52	41.3	20.0	--	EP309R3	132S-4	OK	PAGE 140
34.6	1382	1.01	40.5	12.0	--	EP301R3	132S-4	OK	PAGE 90
34.9	1415	1.24	40.1	9.0	EP303L2	--	132S-4	OK	PAGE 100
34.9	1415	2.32	40.1	9.0	EP305L2	--	132S-4	OK	PAGE 110
35.5	1391	3.40	39.4	13.0	EP306L2	--	132S-4	OK	PAGE 120
36.1	1324	0.96	38.8	7.5	EP301L3	--	132S-4	OK	PAGE 90
36.6	1306	1.98	38.3	14.0	--	EP303R3	132S-4	OK	PAGE 100
36.6	1306	2.24	38.3	14.0	--	EP305R3	132S-4	OK	PAGE 110
43.6	1133	1.55	32.1	9.0	EP303L2	--	132S-4	OK	PAGE 100
43.6	1133	2.79	32.1	9.0	EP305L2	--	132S-4	OK	PAGE 110
43.8	1128	1.16	32.0	7.5	EP301L2	--	132S-4	OK	PAGE 90
45.4	1053	1.23	30.8	12.0	--	EP301R3	132S-4	OK	PAGE 90
46.7	1058	1.78	30.0	9.0	EP303L2	--	132S-4	OK	PAGE 100
46.7	1058	3.02	30.0	9.0	EP305L2	--	132S-4	OK	PAGE 110
48.0	995	2.40	29.1	14.0	--	EP305R3	132S-4	OK	PAGE 110
48.0	995	2.45	29.1	14.0	--	EP303R3	132S-4	OK	PAGE 100
48.5	1017	1.86	28.8	9.0	EP303L2	--	132S-4	OK	PAGE 100
48.5	1017	3.09	28.8	9.0	EP305L2	--	132S-4	OK	PAGE 110
54.6	904	1.27	25.6	7.5	EP301L2	--	132S-4	OK	PAGE 90
55.0	868	2.08	25.4	14.0	--	EP305R3	132S-4	OK	PAGE 110
55.0	868	2.29	25.4	14.0	--	EP303R3	132S-4	OK	PAGE 100
55.6	889	2.01	25.2	9.0	EP303L2	--	132S-4	OK	PAGE 100
55.6	889	3.40	25.2	9.0	EP305L2	--	132S-4	OK	PAGE 110
57.8	854	2.01	24.2	9.0	EP303L2	--	132S-4	OK	PAGE 100

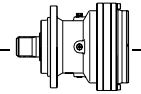

EP300 series gear motor

P1=5.5KW **n1=1400 min⁻¹**

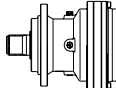
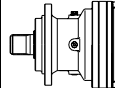
n₂ (min ⁻¹)	M₂ (N.m)	S	I 1:	P_t (KW)			IEC Motor type	Check Thermal Power Pt >= P1	Dimension Page Number
57.8	854	3.40	24.2	9.0	EP305L2	--	132S-4	OK	PAGE 110
59.6	802	1.28	23.5	12.0	--	EP301R3	132S-4	OK	PAGE 90
70.9	697	0.96	19.8	7.5	EP300L2	--	132S-4	OK	PAGE 80
70.9	697	1.55	19.8	7.5	EP301L2	--	132S-4	OK	PAGE 90
75.0	658	2.63	18.7	9.0	EP303L2	--	132S-4	OK	PAGE 100
80.1	616	2.21	17.5	18.0	--	EP303R2	132S-4	OK	PAGE 100
80.1	616	2.21	17.5	18.0	--	EP305R2	132S-4	OK	PAGE 110
93.1	530	1.16	15.0	7.5	EP300L2	--	132S-4	OK	PAGE 80
93.1	530	1.86	15.0	7.5	EP301L2	--	132S-4	OK	PAGE 90
94.9	520	1.70	14.8	12.0	--	EP301R2	132S-4	OK	PAGE 90
98.1	503	2.92	14.3	18.0	--	EP303R2	132S-4	OK	PAGE 100
98.1	503	2.92	14.3	18.0	--	EP305R2	132S-4	OK	PAGE 110
98.5	501	3.40	14.2	9.0	EP303L2	--	132S-4	OK	PAGE 100
118	417	1.16	11.8	12.0	--	EP300R2	132S-4	OK	PAGE 80
118	417	2.17	11.8	12.0	--	EP301R2	132S-4	OK	PAGE 90
122	404	1.39	11.5	7.5	EP300L2	--	132S-4	OK	PAGE 80
122	404	2.32	11.5	7.5	EP301L2	--	132S-4	OK	PAGE 90
154	321	2.32	9.1	12.0	--	EP300R2	132S-4	OK	PAGE 80
154	321	2.32	9.1	12.0	--	EP301R2	132S-4	OK	PAGE 90
194	262	1.65	7.2	7.5	EP300L1	--	132S-4	OK	PAGE 80
194	262	1.65	7.2	7.5	EP300L1	--	132S-4	OK	PAGE 80
194	262	2.70	7.2	7.5	EP301L1	--	132S-4	OK	PAGE 90
202	245	2.32	6.9	12.0	--	EP300R2	132S-4	OK	PAGE 80
202	245	2.32	6.9	12.0	--	EP301R2	132S-4	OK	PAGE 90
243	210	2.25	5.8	7.5	EP300L1	--	132S-4	OK	PAGE 80
315	162	3.00	4.4	7.5	EP300L1	--	132S-4	OK	PAGE 80
414	123	3.00	3.4	7.5	EP300L1	--	132S-4	OK	PAGE 80

EP300 series gear motor

P1=7.5KW **n1=1400 min⁻¹**

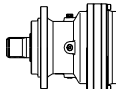
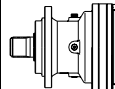
n₂ (min ⁻¹)	M₂ (N.m)	S	I 1:	P_t (KW)			IEC Motor type	Check Thermal Power Pt >= P1	Dimension Page Number
0.7	92460	0.85	2054	18.0	EP315L4	--	132M-4	OK	PAGE 180
0.8	77906	1.09	1731	18.0	EP315L4	--	132M-4	OK	PAGE 180
1.0	63566	1.27	1412	18.0	EP315L4	--	132M-4	OK	PAGE 180
1.0	62558	1.88	1390	18.0	EP316L4	--	132M-4	OK	PAGE 190
1.1	55324	1.27	1229	18.0	EP315L4	--	132M-4	OK	PAGE 180
1.2	52711	2.18	1171	18.0	EP316L4	--	132M-4	OK	PAGE 190
1.3	48588	0.97	1079	11.0	EP313L4	--	132M-4	OK	PAGE 170
1.4	46615	1.70	1036	18.0	EP315L4	--	132M-4	OK	PAGE 180
1.4	44177	2.67	981	18.0	EP316L4	--	132M-4	OK	PAGE 190
1.6	39068	2.12	868	18.0	EP315L4	--	132M-4	OK	PAGE 180
1.6	38932	1.09	865	11.0	EP313L4	--	132M-4	OK	PAGE 170
1.7	37223	3.03	827	18.0	EP316L4	--	132M-4	OK	PAGE 190
1.8	35792	0.97	795	11.0	EP311L4	--	132M-4	OK	PAGE 160
1.8	34939	1.21	776	11.0	EP313L4	--	132M-4	OK	PAGE 170
1.8	34750	1.94	772	40.0	--	EP315R4	132M-4	OK	PAGE 180

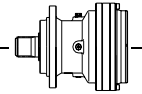

EP300 series gear motor

P1=7.5KW n1=1400 min⁻¹

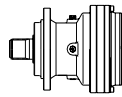
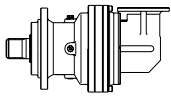
n₂ (min ⁻¹)	M₂ (N.m)	S	I I:	P_t (KW)			IEC Motor type	Check Thermal Power Pt >= P1	Dimension Page Number
1.8	34735	3.39	772	45.0	--	EP316R4	132M-4	OK	PAGE 190
2.1	30417	3.64	676	18.0	EP316L4	--	132M-4	OK	PAGE 190
2.1	29997	1.15	666	11.0	EP311L4	--	132M-4	OK	PAGE 160
2.1	29780	1.33	662	22.0	--	EP313R4	132M-4	OK	PAGE 170
2.2	29283	1.52	650	11.0	EP313L4	--	132M-4	OK	PAGE 170
2.2	29280	2.55	650	40.0	--	EP315R4	132M-4	OK	PAGE 180
2.2	28650	2.79	636	18.0	EP315L4	--	132M-4	OK	PAGE 180
2.5	25197	1.36	560	11.0	EP311L4	--	132M-4	OK	PAGE 160
2.5	25115	1.82	558	22.0	--	EP313R4	132M-4	OK	PAGE 170
2.6	24597	1.82	546	11.0	EP313L4	--	132M-4	OK	PAGE 170
2.6	24468	3.15	544	18.0	EP315L4	--	132M-4	OK	PAGE 180
2.6	24428	1.15	543	22.0	--	EP311R4	132M-4	OK	PAGE 160
2.6	23890	2.79	531	40.0	--	EP315R4	132M-4	OK	PAGE 180
2.8	22855	1.03	508	11.0	EP310L4	--	132M-4	OK	PAGE 150
2.8	22753	0.93	505	14.0	--	EP310R4	132M-4	OK	PAGE 150
3.0	21162	2.12	470	22.0	--	EP313R4	132M-4	OK	PAGE 170
3.0	20792	3.15	462	40.0	--	EP315R4	132M-4	OK	PAGE 180
3.0	20751	3.64	461	18.0	EP315L4	--	132M-4	OK	PAGE 180
3.1	20582	1.61	457	22.0	--	EP311R4	132M-4	OK	PAGE 160
3.2	19634	1.70	436	11.0	EP311L4	--	132M-4	OK	PAGE 160
3.2	19435	0.85	432	14.0	--	EP309R4	132M-4	OK	PAGE 140
3.3	19198	1.15	426	11.0	EP310L4	--	132M-4	OK	PAGE 150
3.3	19198	2.67	426	11.0	EP313L4	--	132M-4	OK	PAGE 170
3.4	18592	1.13	413	14.0	--	EP310R4	132M-4	OK	PAGE 150
3.6	17343	1.88	385	22.0	--	EP311R4	132M-4	OK	PAGE 160
3.6	17292	2.55	384	22.0	--	EP313R4	132M-4	OK	PAGE 170
3.8	16685	1.24	371	14.0	--	EP310R4	132M-4	OK	PAGE 150
3.8	16433	0.97	365	7.5	EP309L4	--	132M-4	OK	PAGE 140
4.0	15573	0.97	346	14.0	--	EP309R4	132M-4	OK	PAGE 140
4.1	15519	2.79	345	22.0	--	EP313R4	132M-4	OK	PAGE 170
4.2	15126	2.18	336	11.0	EP311L4	--	132M-4	OK	PAGE 160
4.2	15345	1.11	330	18.0	EP310L3	--	132M-4	OK	PAGE 150
4.3	14789	1.45	329	11.0	EP310L4	--	132M-4	OK	PAGE 150
4.3	14789	3.39	329	11.0	EP313L4	--	132M-4	OK	PAGE 170
4.4	14250	1.39	317	14.0	--	EP310R4	132M-4	OK	PAGE 150
4.4	14171	2.25	315	22.0	--	EP311R4	132M-4	OK	PAGE 160
4.5	13976	1.09	310	14.0	--	EP309R4	132M-4	OK	PAGE 140
4.8	13006	3.27	289	22.0	--	EP313R4	132M-4	OK	PAGE 170
4.9	12905	2.55	287	11.0	EP311L4	--	132M-4	OK	PAGE 160
5.0	12718	2.48	283	22.0	--	EP311R4	132M-4	OK	PAGE 160
5.0	12598	3.64	280	11.0	EP313L4	--	132M-4	OK	PAGE 170
5.0	12514	1.21	278	7.5	EP309L4	--	132M-4	OK	PAGE 140
5.2	12521	1.35	269	18.0	EP310L3	--	132M-4	OK	PAGE 150
5.2	12085	1.58	268	14.0	--	EP310R4	132M-4	OK	PAGE 150
5.3	12322	1.88	265	18.0	EP311L3	--	132M-4	OK	PAGE 160
5.4	11713	1.27	260	14.0	--	EP309R4	132M-4	OK	PAGE 140
5.4	12018	3.63	258	18.0	EP313L3	--	132M-4	OK	PAGE 170
5.4	11998	0.94	258	11.0	EP309L3	--	132M-4	OK	PAGE 140
5.5	11519	2.79	256	11.0	EP311L4	--	132M-4	OK	PAGE 160
5.6	11263	3.64	250	11.0	EP313L4	--	132M-4	OK	PAGE 170
5.9	10659	2.79	237	22.0	--	EP311R4	132M-4	OK	PAGE 160

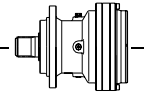

EP300 series gear motor

P1=7.5KW n1=1400 min⁻¹

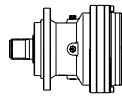
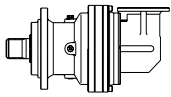
n₂ (min ⁻¹)	M₂ (N.m)	S	I I:	P_t (KW)			IEC Motor type	Check Thermal Power Pt >= P1	Dimension Page Number
6.2	10151	1.82	226	14.0	--	EP310R4	132M-4	OK	PAGE 150
6.3	10383	2.58	223	18.0	EP311L3	--	132M-4	OK	PAGE 160
6.4	10231	1.64	220	18.0	EP310L3	--	132M-4	OK	PAGE 150
6.4	9839	0.85	219	14.0	--	EP307R4	132M-4	OK	PAGE 130
6.4	9839	1.45	219	14.0	--	EP309R4	132M-4	OK	PAGE 140
6.6	9804	0.94	211	11.0	EP307L3	--	132M-4	OK	PAGE 130
6.6	9804	1.52	211	11.0	EP309L3	--	132M-4	OK	PAGE 140
6.7	9370	0.91	208	12.0	--	EP306R4	132M-4	OK	PAGE 120
7.0	8953	3.15	199	22.0	--	EP311R4	132M-4	OK	PAGE 160
7.1	9182	2.23	197	18.0	EP310L3	--	132M-4	OK	PAGE 150
7.4	8527	2.06	189	14.0	--	EP310R4	132M-4	OK	PAGE 150
7.4	8748	2.93	188	18.0	EP311L3	--	132M-4	OK	PAGE 160
8.1	7816	3.52	174	22.0	--	EP311R4	132M-4	OK	PAGE 160
8.3	7856	1.17	169	11.0	EP307L3	--	132M-4	OK	PAGE 130
8.3	7856	1.88	169	11.0	EP309L3	--	132M-4	OK	PAGE 140
8.3	7580	1.09	168	14.0	--	EP307R4	132M-4	OK	PAGE 130
8.3	7580	1.82	168	14.0	--	EP309R4	132M-4	OK	PAGE 140
8.7	7503	2.58	161	18.0	EP310L3	--	132M-4	OK	PAGE 150
8.7	7219	1.15	160	12.0	--	EP306R4	132M-4	OK	PAGE 120
9.1	7149	3.28	154	18.0	EP311L3	--	132M-4	OK	PAGE 160
9.2	7050	1.38	151	11.0	EP307L3	--	132M-4	OK	PAGE 130
9.2	7050	1.99	151	11.0	EP309L3	--	132M-4	OK	PAGE 140
9.6	6537	2.55	145	14.0	--	EP310R4	132M-4	OK	PAGE 150
9.7	6733	2.81	145	18.0	EP310L3	--	132M-4	OK	PAGE 150
9.8	6635	1.05	143	7.5	EP306L3	--	132M-4	OK	PAGE 120
10.2	6415	3.52	138	18.0	EP311L3	--	132M-4	OK	PAGE 160
10.9	5772	1.33	128	14.0	--	EP307R4	132M-4	OK	PAGE 130
10.9	5772	1.88	128	14.0	--	EP309R4	132M-4	OK	PAGE 140
11.0	5908	1.64	127	11.0	EP307L3	--	132M-4	OK	PAGE 130
11.0	5908	2.34	127	11.0	EP309L3	--	132M-4	OK	PAGE 140
11.3	5767	2.34	124	20.0	--	EP310R3	132M-4	OK	PAGE 150
11.3	5750	3.28	124	18.0	EP310L3	--	132M-4	OK	PAGE 150
11.5	5497	1.37	122	12.0	--	EP306R4	132M-4	OK	PAGE 120
12.5	5039	1.45	112	14.0	--	EP307R4	132M-4	OK	PAGE 130
12.9	5068	1.41	109	20.0	--	EP307R3	132M-4	OK	PAGE 130
12.9	5068	1.88	109	20.0	--	EP309R3	132M-4	OK	PAGE 140
13.1	4963	1.88	107	11.0	EP307L3	--	132M-4	OK	PAGE 130
13.1	4963	2.70	107	11.0	EP309L3	--	132M-4	OK	PAGE 140
13.8	4727	1.29	102	7.5	EP306L3	--	132M-4	OK	PAGE 120
13.8	4706	2.81	101	20.0	--	EP310R3	132M-4	OK	PAGE 150
14.1	4614	1.05	99.1	14.0	--	EP306R3	132M-4	OK	PAGE 120
15.0	4215	1.70	93.6	12.0	--	EP306R4	132M-4	OK	PAGE 120
15.3	4270	1.76	91.7	20.0	--	EP307R3	132M-4	OK	PAGE 130
15.3	4270	2.11	91.7	20.0	--	EP309R3	132M-4	OK	PAGE 140
16.2	4019	3.16	86.3	20.0	--	EP310R3	132M-4	OK	PAGE 150
17.0	3823	2.34	82.1	11.0	EP307L3	--	132M-4	OK	PAGE 130
17.0	3823	3.28	82.1	11.0	EP309L3	--	132M-4	OK	PAGE 140
17.1	3818	1.05	82.0	7.5	EP305L3	--	132M-4	OK	PAGE 110
17.3	3765	1.52	80.9	14.0	--	EP306R3	132M-4	OK	PAGE 120
17.9	3641	1.52	78.2	7.5	EP306L3	--	132M-4	OK	PAGE 120
18.7	3489	2.11	75.0	20.0	--	EP307R3	132M-4	OK	PAGE 130

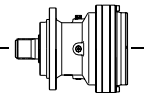

EP300 series gear motor

P1=7.5KW n1=1400 min⁻¹

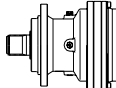
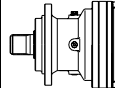
n₂ (min ⁻¹)	M₂ (N.m)	S	I i:	P_t (KW)			IEC Motor type	Check Thermal Power Pt >= P1	Dimension Page Number
18.7	3489	2.34	75.0	20.0	--	EP309R3	132M-4	OK	PAGE 140
19.6	3333	1.05	71.6	7.5	EP305L3	--	132M-4	OK	PAGE 110
20.8	3131	2.34	67.3	20.0	--	EP307R3	132M-4	OK	PAGE 130
20.8	3131	2.58	67.3	20.0	--	EP309R3	132M-4	OK	PAGE 140
21.2	3076	1.76	66.1	14.0	--	EP306R3	132M-4	OK	PAGE 120
21.2	3067	1.05	65.9	14.0	--	EP305R3	132M-4	OK	PAGE 110
22.2	2941	1.05	63.2	7.5	EP305L3	--	132M-4	OK	PAGE 110
22.4	2912	2.93	62.5	11.0	EP307L3	--	132M-4	OK	PAGE 130
22.8	2863	1.17	61.5	14.0	--	EP305R3	132M-4	OK	PAGE 110
23.5	2773	1.93	59.6	7.5	EP306L3	--	132M-4	OK	PAGE 120
23.6	2761	1.93	59.3	14.0	--	EP306R3	132M-4	OK	PAGE 120
23.7	2753	1.17	59.1	14.0	--	EP305R3	132M-4	OK	PAGE 110
24.8	2624	2.34	56.4	20.0	--	EP309R3	132M-4	OK	PAGE 140
24.8	2624	2.58	56.4	20.0	--	EP307R3	132M-4	OK	PAGE 130
25.4	2568	1.17	55.2	7.5	EP305L3	--	132M-4	OK	PAGE 110
25.6	2542	3.28	54.6	11.0	EP307L3	--	132M-4	OK	PAGE 130
27.1	2405	1.08	51.7	14.0	--	EP303R3	132M-4	OK	PAGE 100
27.1	2405	1.41	51.7	14.0	--	EP305R3	132M-4	OK	PAGE 110
27.6	2358	2.23	50.6	14.0	--	EP306R3	132M-4	OK	PAGE 120
28.2	2312	1.02	49.7	14.0	--	EP303R3	132M-4	OK	PAGE 100
28.2	2312	1.41	49.7	14.0	--	EP305R3	132M-4	OK	PAGE 110
28.5	2361	1.13	49.1	9.0	EP305L2	--	132M-4	OK	PAGE 110
29.0	2325	1.82	48.3	13.0	EP306L2	--	132M-4	OK	PAGE 120
29.1	2240	0.94	48.1	7.5	EP303L3	--	132M-4	OK	PAGE 100
29.1	2240	1.41	48.1	7.5	EP305L3	--	132M-4	OK	PAGE 110
29.6	2204	2.34	47.4	20.0	--	EP309R3	132M-4	OK	PAGE 140
29.6	2204	2.93	47.4	20.0	--	EP307R3	132M-4	OK	PAGE 130
30.7	2126	2.46	45.7	7.5	EP306L3	--	132M-4	OK	PAGE 120
32.6	1999	2.70	43.0	14.0	--	EP306R3	132M-4	OK	PAGE 120
33.9	1925	2.58	41.3	20.0	--	EP309R3	132M-4	OK	PAGE 140
33.9	1925	3.28	41.3	20.0	--	EP307R3	132M-4	OK	PAGE 130
34.9	1929	0.91	40.1	9.0	EP303L2	--	132M-4	OK	PAGE 100
34.9	1929	1.70	40.1	9.0	EP305L2	--	132M-4	OK	PAGE 110
35.5	1897	2.50	39.4	13.0	EP306L2	--	132M-4	OK	PAGE 120
36.6	1781	1.45	38.3	14.0	--	EP303R3	132M-4	OK	PAGE 100
36.6	1781	1.64	38.3	14.0	--	EP305R3	132M-4	OK	PAGE 110
38.8	1680	3.16	36.1	14.0	--	EP306R3	132M-4	OK	PAGE 120
43.4	1550	2.72	32.2	13.0	EP306L2	--	132M-4	OK	PAGE 120
43.5	1500	2.93	32.2	20.0	--	EP309R3	132M-4	OK	PAGE 140
43.6	1546	1.13	32.1	9.0	EP303L2	--	132M-4	OK	PAGE 100
43.6	1546	2.04	32.1	9.0	EP305L2	--	132M-4	OK	PAGE 110
43.8	1539	0.85	32.0	7.5	EP301L2	--	132M-4	OK	PAGE 90
45.4	1436	0.90	30.8	12.0	--	EP301R3	132M-4	OK	PAGE 90
46.7	1443	1.30	30.0	9.0	EP303L2	--	132M-4	OK	PAGE 100
46.7	1443	2.21	30.0	9.0	EP305L2	--	132M-4	OK	PAGE 110
48.0	1357	1.76	29.1	14.0	--	EP305R3	132M-4	OK	PAGE 110
48.0	1357	1.79	29.1	14.0	--	EP303R3	132M-4	OK	PAGE 100
48.4	1391	2.95	28.9	13.0	EP306L2	--	132M-4	OK	PAGE 120
48.5	1387	1.36	28.8	9.0	EP303L2	--	132M-4	OK	PAGE 100
48.5	1387	2.27	28.8	9.0	EP305L2	--	132M-4	OK	PAGE 110
54.6	1233	0.93	25.6	7.5	EP301L2	--	132M-4	OK	PAGE 90

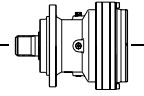

EP300 series gear motor

P1=7.5KW n1=1400 min⁻¹

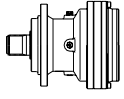
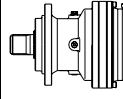
n₂ (min ⁻¹)	M₂ (N.m)	S	I I₁	P_t (KW)			IEC Motor type	Check Thermal Power Pt >= P1	Dimension Page Number
55.0	1184	1.52	25.4	14.0	--	EP305R3	132M-4	OK	PAGE 110
55.0	1184	1.68	25.4	14.0	--	EP303R3	132M-4	OK	PAGE 100
55.6	1212	1.48	25.2	9.0	EP303L2	--	132M-4	OK	PAGE 100
55.6	1212	2.50	25.2	9.0	EP305L2	--	132M-4	OK	PAGE 110
56.7	1188	3.40	24.7	13.0	EP306L2	--	132M-4	OK	PAGE 120
57.8	1165	1.48	24.2	9.0	EP303L2	--	132M-4	OK	PAGE 100
57.8	1165	2.50	24.2	9.0	EP305L2	--	132M-4	OK	PAGE 110
59.6	1093	0.94	23.5	12.0	--	EP301R3	132M-4	OK	PAGE 90
70.9	950	1.13	19.8	7.5	EP301L2	--	132M-4	OK	PAGE 90
75.0	898	1.93	18.7	9.0	EP303L2	--	132M-4	OK	PAGE 100
75.0	898	2.84	18.7	9.0	EP305L2	--	132M-4	OK	PAGE 110
80.1	840	1.62	17.5	18.0	--	EP303R2	132M-4	OK	PAGE 100
80.1	840	1.62	17.5	18.0	--	EP305R2	132M-4	OK	PAGE 110
93.1	723	0.85	15.0	7.5	EP300L2	--	132M-4	OK	PAGE 80
93.1	723	1.36	15.0	7.5	EP301L2	--	132M-4	OK	PAGE 90
94.9	710	1.25	14.8	12.0	--	EP301R2	132M-4	OK	PAGE 90
98.1	687	2.14	14.3	18.0	--	EP303R2	132M-4	OK	PAGE 100
98.1	687	2.14	14.3	18.0	--	EP305R2	132M-4	OK	PAGE 110
98.5	684	2.50	14.2	9.0	EP303L2	--	132M-4	OK	PAGE 100
98.5	684	3.40	14.2	9.0	EP305L2	--	132M-4	OK	PAGE 110
109	616	3.06	12.8	18.0	--	EP303R2	132M-4	OK	PAGE 100
109	616	3.06	12.8	18.0	--	EP305R2	132M-4	OK	PAGE 110
113	597	2.84	12.4	9.0	EP303L2	--	132M-4	OK	PAGE 100
113	597	3.40	12.4	9.0	EP305L2	--	132M-4	OK	PAGE 110
118	569	1.59	11.8	12.0	--	EP301R2	132M-4	OK	PAGE 90
122	551	1.02	11.5	7.5	EP300L2	--	132M-4	OK	PAGE 80
122	551	1.70	11.5	7.5	EP301L2	--	132M-4	OK	PAGE 90
154	438	1.70	9.1	12.0	--	EP300R2	132M-4	OK	PAGE 80
154	438	1.70	9.1	12.0	--	EP301R2	132M-4	OK	PAGE 90
194	357	1.21	7.2	7.5	EP300L1	--	132M-4	OK	PAGE 80
194	357	1.21	7.2	7.5	EP300L1	--	132M-4	OK	PAGE 80
194	357	1.98	7.2	7.5	EP301L1	--	132M-4	OK	PAGE 90
202	334	1.70	6.9	12.0	--	EP300R2	132M-4	OK	PAGE 80
202	334	1.70	6.9	12.0	--	EP301R2	132M-4	OK	PAGE 90
243	286	1.65	5.8	7.5	EP300L1	--	132M-4	OK	PAGE 80
243	286	3.08	5.8	7.5	EP301L1	--	132M-4	OK	PAGE 90
315	221	2.20	4.4	7.5	EP300L1	--	132M-4	OK	PAGE 80
315	221	3.30	4.4	7.5	EP301L1	--	132M-4	OK	PAGE 90
414	168	2.20	3.4	7.5	EP300L1	--	132M-4	OK	PAGE 80

EP300 series gear motor

P1=11KW n1=1400 min⁻¹

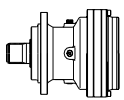
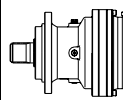
n₂ (min ⁻¹)	M₂ (N.m)	S	I I₁	P_t (KW)			IEC Motor type	Check Thermal Power Pt >= P1	Dimension Page Number
1.0	91752	1.28	1390	18.0	EP316L4	--	160M-4	OK	PAGE 190
1.1	81141	0.87	1229	18.0	EP315L4	--	160M-4	OK	PAGE 180

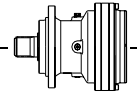

EP300 series gear motor

P1=11KW n1=1400 min⁻¹

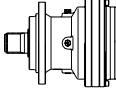
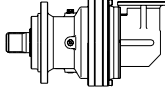
n₂ (min ⁻¹)	M₂ (N.m)	S	I i:	P_t (KW)			IEC Motor type	Check Thermal Power Pt >= P1	Dimension Page Number
1.2	77310	1.49	1171	18.0	EP316L4	--	160M-4	OK	PAGE 190
1.4	68369	1.16	1036	18.0	EP315L4	--	160M-4	OK	PAGE 180
1.4	64793	1.82	981	18.0	EP316L4	--	160M-4	OK	PAGE 190
1.6	57300	1.45	868	18.0	EP315L4	--	160M-4	OK	PAGE 180
1.7	54594	2.07	827	18.0	EP316L4	--	160M-4	OK	PAGE 190
1.8	50966	1.32	772	40.0	--	EP315R4	160M-4	OK	PAGE 180
1.8	50944	2.31	772	45.0	--	EP316R4	160M-4	OK	PAGE 190
2.1	44611	2.48	676	18.0	EP316L4	--	160M-4	OK	PAGE 190
2.1	43678	0.91	662	22.0	--	EP313R4	160M-4	OK	PAGE 170
2.2	42948	1.03	650	11.0	EP313L4	--	160M-4	OK	PAGE 170
2.2	42944	1.74	650	40.0	--	EP315R4	160M-4	OK	PAGE 180
2.2	42925	2.73	650	45.0	--	EP316R4	160M-4	OK	PAGE 190
2.2	42020	1.90	636	18.0	EP315L4	--	160M-4	OK	PAGE 180
2.3	40036	2.81	606	18.0	EP316L4	--	160M-4	OK	PAGE 190
2.5	36956	0.93	560	11.0	EP311L4	--	160M-4	OK	PAGE 160
2.5	36836	1.24	558	22.0	--	EP313R4	160M-4	OK	PAGE 170
2.6	36076	1.24	546	11.0	EP313L4	--	160M-4	OK	PAGE 170
2.6	35975	3.31	545	45.0	--	EP316R4	160M-4	OK	PAGE 190
2.6	35886	2.15	544	18.0	EP315L4	--	160M-4	OK	PAGE 180
2.6	35039	1.90	531	40.0	--	EP315R4	160M-4	OK	PAGE 180
2.8	33554	3.31	508	18.0	EP316L4	--	160M-4	OK	PAGE 190
3.0	31038	1.45	470	22.0	--	EP313R4	160M-4	OK	PAGE 170
3.0	30496	2.15	462	40.0	--	EP315R4	160M-4	OK	PAGE 180
3.0	30434	2.48	461	18.0	EP315L4	--	160M-4	OK	PAGE 180
3.1	30188	1.10	457	22.0	--	EP311R4	160M-4	OK	PAGE 160
3.2	28797	1.16	436	11.0	EP311L4	--	160M-4	OK	PAGE 160
3.3	28157	1.82	426	11.0	EP313L4	--	160M-4	OK	PAGE 170
3.6	25695	2.64	389	40.0	--	EP315R4	160M-4	OK	PAGE 180
3.6	25565	2.89	387	18.0	EP315L4	--	160M-4	OK	PAGE 180
3.6	25436	1.28	385	22.0	--	EP311R4	160M-4	OK	PAGE 160
3.6	25362	1.74	384	22.0	--	EP313R4	160M-4	OK	PAGE 170
3.8	24472	0.84	371	14.0	--	EP310R4	160M-4	OK	PAGE 150
4.1	22761	1.90	345	22.0	--	EP313R4	160M-4	OK	PAGE 170
4.2	22184	1.49	336	11.0	EP311L4	--	160M-4	OK	PAGE 160
4.3	21691	0.99	329	11.0	EP310L4	--	160M-4	OK	PAGE 150
4.3	21691	2.31	329	11.0	EP313L4	--	160M-4	OK	PAGE 170
4.3	21535	3.55	326	40.0	--	EP315R4	160M-4	OK	PAGE 180
4.4	20900	0.95	317	14.0	--	EP310R4	160M-4	OK	PAGE 150
4.4	20785	1.54	315	22.0	--	EP311R4	160M-4	OK	PAGE 160
4.6	20567	2.98	301	30.0	EP315L3	--	160M-4	OK	PAGE 180
4.8	19076	2.23	289	22.0	--	EP313R4	160M-4	OK	PAGE 170
4.9	18928	1.74	287	11.0	EP311L4	--	160M-4	OK	PAGE 160
5.0	18653	1.69	283	22.0	--	EP311R4	160M-4	OK	PAGE 160
5.0	18477	2.48	280	11.0	EP313L4	--	160M-4	OK	PAGE 170
5.2	18364	0.92	269	18.0	EP310L3	--	160M-4	OK	PAGE 150
5.2	17724	1.07	268	14.0	--	EP310R4	160M-4	OK	PAGE 150
5.3	18072	1.28	265	18.0	EP311L3	--	160M-4	OK	PAGE 160
5.4	17626	2.48	258	18.0	EP313L3	--	160M-4	OK	PAGE 170
5.5	16894	1.90	256	11.0	EP311L4	--	160M-4	OK	PAGE 160
5.6	16519	2.48	250	11.0	EP313L4	--	160M-4	OK	PAGE 170
5.8	16024	2.56	243	22.0	--	EP313R4	160M-4	OK	PAGE 170

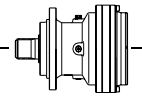

EP300 series gear motor

P1=11KW n1=1400 min⁻¹

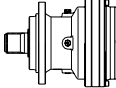
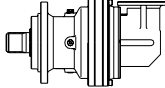
n₂ (min ⁻¹)	M₂ (N.m)	S	I I:	P_t (KW)			IEC Motor type	Check Thermal Power Pt >= P1	Dimension Page Number
5.9	15633	1.90	237	22.0	--	EP311R4	160M-4	OK	PAGE 160
6.2	14889	1.24	226	14.0	--	EP310R4	160M-4	OK	PAGE 150
6.3	15228	1.76	223	18.0	EP311L3	--	160M-4	OK	PAGE 160
6.4	15006	1.12	220	18.0	EP310L3	--	160M-4	OK	PAGE 150
6.4	14430	0.99	219	14.0	--	EP309R4	160M-4	OK	PAGE 140
6.4	14865	2.88	218	18.0	EP313L3	--	160M-4	OK	PAGE 170
6.6	13989	2.89	212	22.0	--	EP313R4	160M-4	OK	PAGE 170
6.6	14379	1.04	211	11.0	EP309L3	--	160M-4	OK	PAGE 140
7.0	13132	2.15	199	22.0	--	EP311R4	160M-4	OK	PAGE 160
7.1	13467	1.52	197	18.0	EP310L3	--	160M-4	OK	PAGE 150
7.4	12506	1.40	189	14.0	--	EP310R4	160M-4	OK	PAGE 150
7.4	12506	2.89	189	22.0	--	EP313R4	160M-4	OK	PAGE 170
7.4	12831	2.00	188	18.0	EP311L3	--	160M-4	OK	PAGE 160
7.6	12525	3.20	183	18.0	EP313L3	--	160M-4	OK	PAGE 170
8.1	11464	2.40	174	22.0	--	EP311R4	160M-4	OK	PAGE 160
8.3	11521	1.28	169	11.0	EP309L3	--	160M-4	OK	PAGE 140
8.3	11117	1.24	168	14.0	--	EP309R4	160M-4	OK	PAGE 140
8.5	10918	2.89	165	22.0	--	EP313R4	160M-4	OK	PAGE 170
8.7	11004	1.76	161	18.0	EP310L3	--	160M-4	OK	PAGE 150
9.0	10232	2.64	155	22.0	--	EP311R4	160M-4	OK	PAGE 160
9.1	10485	2.24	154	18.0	EP311L3	--	160M-4	OK	PAGE 160
9.2	10340	0.94	151	11.0	EP307L3	--	160M-4	OK	PAGE 130
9.2	10340	1.36	151	11.0	EP309L3	--	160M-4	OK	PAGE 140
9.3	10235	3.60	150	18.0	EP313L3	--	160M-4	OK	PAGE 170
9.6	9588	1.74	145	14.0	--	EP310R4	160M-4	OK	PAGE 150
9.7	9876	1.92	145	18.0	EP310L3	--	160M-4	OK	PAGE 150
9.8	9787	3.20	143	40.0	--	EP313R3	160M-4	OK	PAGE 170
10.2	9409	2.40	138	18.0	EP311L3	--	160M-4	OK	PAGE 160
10.9	8508	2.89	129	22.0	--	EP313R4	160M-4	OK	PAGE 170
10.9	8466	1.28	128	14.0	--	EP309R4	160M-4	OK	PAGE 140
11.0	8666	1.12	127	11.0	EP307L3	--	160M-4	OK	PAGE 130
11.0	8666	1.60	127	11.0	EP309L3	--	160M-4	OK	PAGE 140
11.3	8459	1.60	124	20.0	--	EP310R3	160M-4	OK	PAGE 150
11.3	8455	2.80	124	40.0	--	EP311R3	160M-4	OK	PAGE 160
11.3	8434	2.24	124	18.0	EP310L3	--	160M-4	OK	PAGE 150
11.5	8063	0.93	122	12.0	--	EP306R4	160M-4	OK	PAGE 120
11.6	8254	3.60	121	40.0	--	EP313R3	160M-4	OK	PAGE 170
12.1	7886	2.80	116	18.0	EP311L3	--	160M-4	OK	PAGE 160
12.5	7391	0.99	112	14.0	--	EP307R4	160M-4	OK	PAGE 130
12.9	7433	0.96	109	20.0	--	EP307R3	160M-4	OK	PAGE 130
12.9	7433	1.28	109	20.0	--	EP309R3	160M-4	OK	PAGE 140
13.1	7279	1.28	107	11.0	EP307L3	--	160M-4	OK	PAGE 130
13.1	7279	1.84	107	11.0	EP309L3	--	160M-4	OK	PAGE 140
13.4	7153	2.56	105	18.0	EP310L3	--	160M-4	OK	PAGE 150
13.4	7124	3.20	104	40.0	--	EP311R3	160M-4	OK	PAGE 160
13.8	6933	0.88	102	7.5	EP306L3	--	160M-4	NO !	PAGE 120
13.8	6902	1.92	101	20.0	--	EP310R3	160M-4	OK	PAGE 150
14.4	6624	3.04	97.0	18.0	EP311L3	--	160M-4	OK	PAGE 160
15.0	6181	1.16	93.6	12.0	--	EP306R4	160M-4	OK	PAGE 120
15.3	6263	1.20	91.7	20.0	--	EP307R3	160M-4	OK	PAGE 130
15.3	6263	1.44	91.7	20.0	--	EP309R3	160M-4	OK	PAGE 140

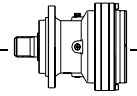

EP300 series gear motor

P1=11KW n1=1400 min⁻¹

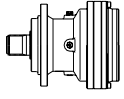
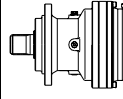
n₂ (min ⁻¹)	M₂ (N.m)	S	I I:	P_t (KW)			IEC Motor type	Check Thermal Power Pt >= P1	Dimension Page Number
15.9	6008	2.96	88.0	18.0	EP310L3	--	160M-4	OK	PAGE 150
16.2	5894	2.16	86.3	20.0	--	EP310R3	160M-4	OK	PAGE 150
16.5	5783	3.36	84.7	18.0	EP311L3	--	160M-4	OK	PAGE 160
17.0	5608	1.60	82.1	11.0	EP307L3	--	160M-4	OK	PAGE 130
17.0	5608	2.24	82.1	11.0	EP309L3	--	160M-4	OK	PAGE 140
17.3	5521	1.04	80.9	14.0	--	EP306R3	160M-4	OK	PAGE 120
17.9	5341	1.04	78.2	7.5	EP306L3	--	160M-4	NO !	PAGE 120
18.7	5117	1.44	75.0	20.0	--	EP307R3	160M-4	OK	PAGE 130
18.7	5117	1.60	75.0	20.0	--	EP309R3	160M-4	OK	PAGE 140
18.9	5061	2.64	74.1	20.0	--	EP310R3	160M-4	OK	PAGE 150
18.9	5047	3.36	73.9	18.0	EP310L3	--	160M-4	OK	PAGE 150
20.8	4593	1.60	67.3	20.0	--	EP307R3	160M-4	OK	PAGE 130
20.8	4593	1.76	67.3	20.0	--	EP309R3	160M-4	OK	PAGE 140
21.2	4512	1.20	66.1	14.0	--	EP306R3	160M-4	OK	PAGE 120
22.1	4322	2.96	63.3	20.0	--	EP310R3	160M-4	OK	PAGE 150
22.4	4270	2.00	62.5	11.0	EP307L3	--	160M-4	OK	PAGE 130
22.4	4270	2.64	62.5	11.0	EP309L3	--	160M-4	OK	PAGE 140
23.5	4067	1.32	59.6	7.5	EP306L3	--	160M-4	NO !	PAGE 120
23.6	4049	1.32	59.3	14.0	--	EP306R3	160M-4	OK	PAGE 120
24.8	3849	1.60	56.4	20.0	--	EP309R3	160M-4	OK	PAGE 140
24.8	3849	1.76	56.4	20.0	--	EP307R3	160M-4	OK	PAGE 130
25.6	3728	2.24	54.6	11.0	EP307L3	--	160M-4	OK	PAGE 130
25.6	3728	2.88	54.6	11.0	EP309L3	--	160M-4	OK	PAGE 140
26.1	3666	3.28	53.7	20.0	--	EP310R3	160M-4	OK	PAGE 150
27.1	3527	0.96	51.7	14.0	--	EP305R3	160M-4	OK	PAGE 110
27.6	3458	1.52	50.6	14.0	--	EP306R3	160M-4	OK	PAGE 120
28.2	3391	0.96	49.7	14.0	--	EP305R3	160M-4	OK	PAGE 110
29.0	3410	1.24	48.3	13.0	EP306L2	--	160M-4	OK	PAGE 120
29.1	3285	0.96	48.1	7.5	EP305L3	--	160M-4	NO !	PAGE 110
29.6	3233	1.60	47.4	20.0	--	EP309R3	160M-4	OK	PAGE 140
29.6	3233	2.00	47.4	20.0	--	EP307R3	160M-4	OK	PAGE 130
30.7	3118	1.68	45.7	7.5	EP306L3	--	160M-4	NO !	PAGE 120
31.0	3079	3.60	45.1	20.0	--	EP310R3	160M-4	OK	PAGE 150
32.6	2933	1.84	43.0	14.0	--	EP306R3	160M-4	OK	PAGE 120
32.9	2905	3.36	42.5	11.0	EP309L3	--	160M-4	OK	PAGE 140
33.0	2996	2.48	42.5	18.0	EP307L2	--	160M-4	OK	PAGE 130
33.0	2996	3.25	42.5	18.0	EP309L2	--	160M-4	OK	PAGE 140
33.9	2823	1.76	41.3	20.0	--	EP309R3	160M-4	OK	PAGE 140
34.9	2829	1.16	40.1	9.0	EP305L2	--	160M-4	NO !	PAGE 110
35.3	2704	3.60	39.6	20.0	--	EP310R3	160M-4	OK	PAGE 150
35.5	2782	1.70	39.4	13.0	EP306L2	--	160M-4	OK	PAGE 120
36.6	2613	0.99	38.3	14.0	--	EP303R3	160M-4	OK	PAGE 100
36.6	2613	1.12	38.3	14.0	--	EP305R3	160M-4	OK	PAGE 110
38.8	2463	2.16	36.1	14.0	--	EP306R3	160M-4	OK	PAGE 120
39.1	2525	2.86	35.8	18.0	EP307L2	--	160M-4	OK	PAGE 130
43.4	2273	1.86	32.2	13.0	EP306L2	--	160M-4	OK	PAGE 120
43.5	2199	2.00	32.2	20.0	--	EP309R3	160M-4	OK	PAGE 140
43.5	2199	2.40	32.2	20.0	--	EP307R3	160M-4	OK	PAGE 130
43.6	2267	1.39	32.1	9.0	EP305L2	--	160M-4	NO !	PAGE 110
46.7	2116	0.89	30.0	9.0	EP303L2	--	160M-4	NO !	PAGE 100
46.7	2116	1.51	30.0	9.0	EP305L2	--	160M-4	NO !	PAGE 110

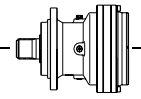

EP300 series gear motor

P1=11KW n1=1400 min⁻¹

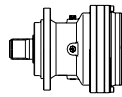
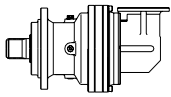
n₂ (min ⁻¹)	M₂ (N.m)	S	I i:	P_t (KW)			IEC Motor type	Check Thermal Power Pt >= P1	Dimension Page Number
47.9	2063	3.48	29.3	18.0	EP307L2	--	160M-4	OK	PAGE 130
48.0	1990	1.20	29.1	14.0	--	EP305R3	160M-4	OK	PAGE 110
48.0	1990	1.22	29.1	14.0	--	EP303R3	160M-4	OK	PAGE 100
48.4	2040	2.01	28.9	13.0	EP306L2	--	160M-4	OK	PAGE 120
48.5	2034	0.93	28.8	9.0	EP303L2	--	160M-4	NO !	PAGE 100
48.5	2034	1.55	28.8	9.0	EP305L2	--	160M-4	NO !	PAGE 110
50.6	1889	2.80	27.7	14.0	--	EP306R3	160M-4	OK	PAGE 120
55.0	1737	1.04	25.4	14.0	--	EP305R3	160M-4	OK	PAGE 110
55.0	1737	1.14	25.4	14.0	--	EP303R3	160M-4	OK	PAGE 100
55.6	1777	1.01	25.2	9.0	EP303L2	--	160M-4	NO !	PAGE 100
55.6	1777	1.70	25.2	9.0	EP305L2	--	160M-4	NO !	PAGE 110
56.7	1742	2.32	24.7	13.0	EP306L2	--	160M-4	OK	PAGE 120
57.8	1709	1.01	24.2	9.0	EP303L2	--	160M-4	NO !	PAGE 100
57.8	1709	1.70	24.2	9.0	EP305L2	--	160M-4	NO !	PAGE 110
59.4	1664	3.25	23.6	35.0	--	EP307R2	160M-4	OK	PAGE 130
59.4	1664	3.48	23.6	35.0	--	EP309R2	160M-4	OK	PAGE 140
66.8	1478	3.09	21.0	13.0	EP306L2	--	160M-4	OK	PAGE 120
70.4	1402	3.48	19.9	35.0	--	EP309R2	160M-4	OK	PAGE 140
75.0	1316	1.32	18.7	9.0	EP303L2	--	160M-4	NO !	PAGE 100
75.0	1316	1.93	18.7	9.0	EP305L2	--	160M-4	NO !	PAGE 110
77.0	1281	2.71	18.2	18.0	--	EP306R2	160M-4	OK	PAGE 120
79.5	1241	3.09	17.6	13.0	EP306L2	--	160M-4	OK	PAGE 120
80.1	1232	1.11	17.5	18.0	--	EP303R2	160M-4	OK	PAGE 100
80.1	1232	1.11	17.5	18.0	--	EP305R2	160M-4	OK	PAGE 110
93.1	1061	0.93	15.0	7.5	EP301L2	--	160M-4	NO !	PAGE 90
94.4	1046	2.71	14.8	18.0	--	EP306R2	160M-4	OK	PAGE 120
94.9	1041	0.85	14.8	12.0	--	EP301R2	160M-4	OK	PAGE 90
98.1	1007	1.46	14.3	18.0	--	EP303R2	160M-4	OK	PAGE 100
98.1	1007	1.46	14.3	18.0	--	EP305R2	160M-4	OK	PAGE 110
98.5	1003	1.70	14.2	9.0	EP303L2	--	160M-4	NO !	PAGE 100
98.5	1003	2.32	14.2	9.0	EP305L2	--	160M-4	NO !	PAGE 110
104	952	3.09	13.5	13.0	EP306L2	--	160M-4	OK	PAGE 120
109	904	2.09	12.8	18.0	--	EP303R2	160M-4	OK	PAGE 100
109	904	2.09	12.8	18.0	--	EP305R2	160M-4	OK	PAGE 110
111	893	2.71	12.7	18.0	--	EP306R2	160M-4	OK	PAGE 120
113	875	1.93	12.4	9.0	EP303L2	--	160M-4	NO !	PAGE 100
113	875	2.32	12.4	9.0	EP305L2	--	160M-4	NO !	PAGE 110
118	834	1.08	11.8	12.0	--	EP301R2	160M-4	OK	PAGE 90
122	808	1.16	11.5	7.5	EP301L2	--	160M-4	NO !	PAGE 90
130	759	2.71	10.8	18.0	--	EP303R2	160M-4	OK	PAGE 100
130	759	2.71	10.8	18.0	--	EP305R2	160M-4	OK	PAGE 110
130	757	2.71	10.7	18.0	--	EP306R2	160M-4	OK	PAGE 120
148	665	2.71	9.4	18.0	--	EP306R2	160M-4	OK	PAGE 120
149	663	2.71	9.4	18.0	--	EP303R2	160M-4	OK	PAGE 100
149	663	2.71	9.4	18.0	--	EP305R2	160M-4	OK	PAGE 110
154	643	1.16	9.1	12.0	--	EP301R2	160M-4	OK	PAGE 90
194	524	1.35	7.2	7.5	EP301L1	--	160M-4	NO !	PAGE 90
202	489	1.16	6.9	12.0	--	EP301R2	160M-4	OK	PAGE 90
205	496	2.70	6.8	11.0	EP303L1	--	160M-4	OK	PAGE 100
243	420	1.12	5.8	7.5	EP300L1	--	160M-4	NO !	PAGE 80
243	420	2.10	5.8	7.5	EP301L1	--	160M-4	NO !	PAGE 90

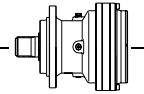

EP300 series gear motor

P1=11KW n1=1400 min⁻¹

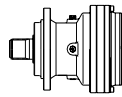
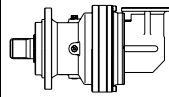
n₂ (min ⁻¹)	M₂ (N.m)	S	I 1:	P_t (KW)			IEC Motor type	Check Thermal Power Pt >= P1	Dimension Page Number
251	405	3.00	5.6	11.0	EP303L1	--	160M-4	OK	PAGE 100
280	364	3.00	5.0	11.0	EP303L1	--	160M-4	OK	PAGE 100
280	364	3.00	5.0	11.0	EP303L1	--	160M-4	OK	PAGE 100
315	323	1.50	4.4	7.5	EP300L1	--	160M-4	NO !	PAGE 80
315	323	2.25	4.4	7.5	EP301L1	--	160M-4	NO !	PAGE 90
333	306	3.00	4.2	11.0	EP303L1	--	160M-4	OK	PAGE 100
382	267	3.00	3.7	11.0	EP303L1	--	160M-4	OK	PAGE 100
414	246	1.50	3.4	7.5	EP300L1	--	160M-4	NO !	PAGE 80
414	246	2.25	3.4	7.5	EP301L1	--	160M-4	NO !	PAGE 90

EP300 series gear motor

P1=15KW n1=1400 min⁻¹

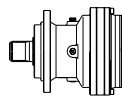
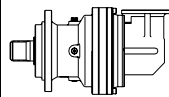
n₂ (min ⁻¹)	M₂ (N.m)	S	I 1:	P_t (KW)			IEC Motor type	Check Thermal Power Pt >= P1	Dimension Page Number
1.0	125117	0.94	1390	18.0	EP316L4	--	160L-4	OK	PAGE 190
1.2	105422	1.09	1171	18.0	EP316L4	--	160L-4	OK	PAGE 190
1.4	93231	0.85	1036	18.0	EP315L4	--	160L-4	OK	PAGE 180
1.4	88354	1.33	981	18.0	EP316L4	--	160L-4	OK	PAGE 190
1.6	78136	1.06	868	18.0	EP315L4	--	160L-4	OK	PAGE 180
1.7	74446	1.52	827	18.0	EP316L4	--	160L-4	OK	PAGE 190
1.8	69499	0.97	772	40.0	--	EP315R4	160L-4	OK	PAGE 180
1.8	69470	1.70	772	45.0	--	EP316R4	160L-4	OK	PAGE 190
2.1	60833	1.82	676	18.0	EP316L4	--	160L-4	OK	PAGE 190
2.2	58560	1.27	650	40.0	--	EP315R4	160L-4	OK	PAGE 180
2.2	58534	2.00	650	45.0	--	EP316R4	160L-4	OK	PAGE 190
2.2	57300	1.39	636	18.0	EP315L4	--	160L-4	OK	PAGE 180
2.3	54594	2.06	606	18.0	EP316L4	--	160L-4	OK	PAGE 190
2.5	50231	0.91	558	22.0	--	EP313R4	160L-4	OK	PAGE 170
2.6	49195	0.91	546	11.0	EP313L4	--	160L-4	NO !	PAGE 170
2.6	49057	2.42	545	45.0	--	EP316R4	160L-4	OK	PAGE 190
2.6	48936	1.58	544	18.0	EP315L4	--	160L-4	OK	PAGE 180
2.6	47781	1.39	531	40.0	--	EP315R4	160L-4	OK	PAGE 180
2.8	45755	2.42	508	18.0	EP316L4	--	160L-4	OK	PAGE 190
3.0	42324	1.06	470	22.0	--	EP313R4	160L-4	OK	PAGE 170
3.0	41585	1.58	462	40.0	--	EP315R4	160L-4	OK	PAGE 180
3.0	41501	1.82	461	18.0	EP315L4	--	160L-4	OK	PAGE 180
3.0	41335	2.73	459	45.0	--	EP316R4	160L-4	OK	PAGE 190
3.2	39268	0.85	436	11.0	EP311L4	--	160L-4	NO !	PAGE 160
3.3	38434	2.85	427	18.0	EP316L4	--	160L-4	OK	PAGE 190
3.3	38396	1.33	426	11.0	EP313L4	--	160L-4	NO !	PAGE 170
3.5	35653	3.09	396	18.0	EP316L4	--	160L-4	OK	PAGE 190
3.6	35039	1.94	389	40.0	--	EP315R4	160L-4	OK	PAGE 180
3.6	34861	2.12	387	18.0	EP315L4	--	160L-4	OK	PAGE 180
3.6	34685	0.94	385	22.0	--	EP311R4	160L-4	OK	PAGE 160
3.6	34643	3.15	385	45.0	--	EP316R4	160L-4	OK	PAGE 190
3.6	34585	1.27	384	22.0	--	EP313R4	160L-4	OK	PAGE 170

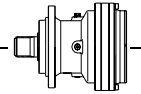

EP300 series gear motor

P1=15KW n1=1400 min⁻¹

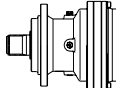
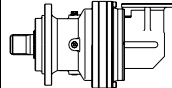
n₂ (min ⁻¹)	M₂ (N.m)	S	I i:	P_t (KW)			IEC Motor type	Check Thermal Power Pt >= P1	Dimension Page Number
4.1	31038	1.39	345	22.0	--	EP313R4	160L-4	OK	PAGE 170
4.2	30371	3.03	337	18.0	EP315L4	--	160L-4	OK	PAGE 180
4.2	30251	1.09	336	11.0	EP311L4	--	160L-4	NO !	PAGE 160
4.3	29579	1.70	329	11.0	EP313L4	--	160L-4	NO !	PAGE 170
4.3	29366	2.61	326	40.0	--	EP315R4	160L-4	OK	PAGE 180
4.4	28343	1.13	315	22.0	--	EP311R4	160L-4	OK	PAGE 160
4.6	28046	2.19	301	30.0	EP315L3	--	160L-4	OK	PAGE 180
4.8	26013	1.64	289	22.0	--	EP313R4	160L-4	OK	PAGE 170
4.9	25811	1.27	287	11.0	EP311L4	--	160L-4	NO !	PAGE 160
5.0	25436	1.24	283	22.0	--	EP311R4	160L-4	OK	PAGE 160
5.0	25196	1.82	280	11.0	EP313L4	--	160L-4	NO !	PAGE 170
5.0	25080	3.03	279	40.0	--	EP315R4	160L-4	OK	PAGE 180
5.3	24644	0.94	265	18.0	EP311L3	--	160L-4	OK	PAGE 160
5.4	24036	1.82	258	18.0	EP313L3	--	160L-4	OK	PAGE 170
5.5	23037	1.39	256	11.0	EP311L4	--	160L-4	NO !	PAGE 160
5.5	23632	2.87	254	30.0	EP315L3	--	160L-4	OK	PAGE 180
5.6	22526	1.82	250	11.0	EP313L4	--	160L-4	NO !	PAGE 170
5.8	21851	1.88	243	22.0	--	EP313R4	160L-4	OK	PAGE 170
5.9	21318	1.39	237	22.0	--	EP311R4	160L-4	OK	PAGE 160
6.2	20303	0.91	226	14.0	--	EP310R4	160L-4	NO !	PAGE 150
6.3	20765	1.29	223	18.0	EP311L3	--	160L-4	OK	PAGE 160
6.4	20271	2.11	218	18.0	EP313L3	--	160L-4	OK	PAGE 170
6.6	19076	2.12	212	22.0	--	EP313R4	160L-4	OK	PAGE 170
6.9	18976	3.42	204	30.0	EP316L3	--	160L-4	OK	PAGE 190
7.0	17907	1.58	199	22.0	--	EP311R4	160L-4	OK	PAGE 160
7.1	18364	1.11	197	18.0	EP310L3	--	160L-4	OK	PAGE 150
7.4	17054	1.03	189	14.0	--	EP310R4	160L-4	NO !	PAGE 150
7.4	17054	2.12	189	22.0	--	EP313R4	160L-4	OK	PAGE 170
7.4	17496	1.47	188	18.0	EP311L3	--	160L-4	OK	PAGE 160
7.6	17080	2.34	183	18.0	EP313L3	--	160L-4	OK	PAGE 170
8.1	15633	1.76	174	22.0	--	EP311R4	160L-4	OK	PAGE 160
8.5	14889	2.12	165	22.0	--	EP313R4	160L-4	OK	PAGE 170
8.7	15006	1.29	161	18.0	EP310L3	--	160L-4	OK	PAGE 150
9.0	13953	1.94	155	22.0	--	EP311R4	160L-4	OK	PAGE 160
9.1	14297	1.64	154	18.0	EP311L3	--	160L-4	OK	PAGE 160
9.2	14100	1.00	151	11.0	EP309L3	--	160L-4	NO !	PAGE 140
9.3	13957	2.64	150	18.0	EP313L3	--	160L-4	OK	PAGE 170
9.6	13075	1.27	145	14.0	--	EP310R4	160L-4	NO !	PAGE 150
9.7	13467	1.41	145	18.0	EP310L3	--	160L-4	OK	PAGE 150
9.8	13346	2.34	143	40.0	--	EP313R3	160L-4	OK	PAGE 170
10.2	12831	1.76	138	18.0	EP311L3	--	160L-4	OK	PAGE 160
10.4	12525	2.93	135	18.0	EP313L3	--	160L-4	OK	PAGE 170
10.9	11601	2.12	129	22.0	--	EP313R4	160L-4	OK	PAGE 170
10.9	11544	0.94	128	14.0	--	EP309R4	160L-4	NO !	PAGE 140
11.0	11817	1.17	127	11.0	EP309L3	--	160L-4	NO !	PAGE 140
11.3	11534	1.17	124	20.0	--	EP310R3	160L-4	OK	PAGE 150
11.3	11530	2.05	124	40.0	--	EP311R3	160L-4	OK	PAGE 160
11.3	11501	1.64	124	18.0	EP310L3	--	160L-4	OK	PAGE 150
11.6	11255	2.64	121	40.0	--	EP313R3	160L-4	OK	PAGE 170
12.1	10753	2.05	116	18.0	EP311L3	--	160L-4	OK	PAGE 160
12.4	10497	3.22	113	18.0	EP313L3	--	160L-4	OK	PAGE 170

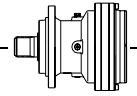

EP300 series gear motor

P1=15KW n1=1400 min⁻¹

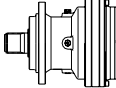
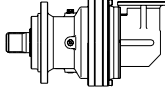
n₂ (min ⁻¹)	M₂ (N.m)	S	I I:	P_t (KW)			IEC Motor type	Check Thermal Power Pt >= P1	Dimension Page Number
12.9	10135	0.94	109	20.0	--	EP309R3	160L-4	OK	PAGE 140
13.1	9926	0.94	107	11.0	EP307L3	--	160L-4	NO !	PAGE 130
13.1	9926	1.35	107	11.0	EP309L3	--	160L-4	NO !	PAGE 140
13.4	9754	1.88	105	18.0	EP310L3	--	160L-4	OK	PAGE 150
13.4	9715	2.34	104	40.0	--	EP311R3	160L-4	OK	PAGE 160
13.7	9483	2.93	102	40.0	--	EP313R3	160L-4	OK	PAGE 170
13.8	9411	1.41	101	20.0	--	EP310R3	160L-4	OK	PAGE 150
14.4	9033	2.23	97.0	18.0	EP311L3	--	160L-4	OK	PAGE 160
14.8	8818	3.22	94.7	18.0	EP313L3	--	160L-4	OK	PAGE 170
15.3	8540	0.88	91.7	20.0	--	EP307R3	160L-4	OK	PAGE 130
15.3	8540	1.05	91.7	20.0	--	EP309R3	160L-4	OK	PAGE 140
15.9	8193	2.17	88.0	18.0	EP310L3	--	160L-4	OK	PAGE 150
16.0	8142	2.64	87.5	40.0	--	EP311R3	160L-4	OK	PAGE 160
16.2	8038	1.58	86.3	20.0	--	EP310R3	160L-4	OK	PAGE 150
16.5	7886	2.46	84.7	18.0	EP311L3	--	160L-4	OK	PAGE 160
16.9	7698	3.40	82.7	18.0	EP313L3	--	160L-4	OK	PAGE 170
17.0	7647	1.17	82.1	11.0	EP307L3	--	160L-4	NO !	PAGE 130
17.0	7647	1.64	82.1	11.0	EP309L3	--	160L-4	NO !	PAGE 140
18.5	7039	2.70	75.6	18.0	EP311L3	--	160L-4	OK	PAGE 160
18.7	6978	1.05	75.0	20.0	--	EP307R3	160L-4	OK	PAGE 130
18.7	6978	1.17	75.0	20.0	--	EP309R3	160L-4	OK	PAGE 140
18.9	6902	1.93	74.1	20.0	--	EP310R3	160L-4	OK	PAGE 150
18.9	6882	2.46	73.9	18.0	EP310L3	--	160L-4	OK	PAGE 150
18.9	6882	3.52	73.9	18.0	EP313L3	--	160L-4	OK	PAGE 170
20.5	6344	2.93	68.1	40.0	--	EP311R3	160L-4	OK	PAGE 160
20.8	6263	1.17	67.3	20.0	--	EP307R3	160L-4	OK	PAGE 130
20.8	6263	1.29	67.3	20.0	--	EP309R3	160L-4	OK	PAGE 140
21.2	6152	0.88	66.1	14.0	--	EP306R3	160L-4	NO !	PAGE 120
21.2	6145	2.93	66.0	18.0	EP311L3	--	160L-4	OK	PAGE 160
22.1	5894	2.17	63.3	20.0	--	EP310R3	160L-4	OK	PAGE 150
22.4	5823	1.47	62.5	11.0	EP307L3	--	160L-4	NO !	PAGE 130
22.4	5823	1.93	62.5	11.0	EP309L3	--	160L-4	NO !	PAGE 140
23.6	5521	0.97	59.3	14.0	--	EP306R3	160L-4	NO !	PAGE 120
24.7	5276	2.93	56.7	18.0	EP310L3	--	160L-4	OK	PAGE 150
24.8	5249	1.17	56.4	20.0	--	EP309R3	160L-4	OK	PAGE 140
24.8	5249	1.29	56.4	20.0	--	EP307R3	160L-4	OK	PAGE 130
25.6	5084	1.64	54.6	11.0	EP307L3	--	160L-4	NO !	PAGE 130
25.6	5084	2.11	54.6	11.0	EP309L3	--	160L-4	NO !	PAGE 140
26.1	4999	2.40	53.7	20.0	--	EP310R3	160L-4	OK	PAGE 150
27.6	4715	1.11	50.6	14.0	--	EP306R3	160L-4	NO !	PAGE 120
29.0	4650	0.91	48.3	13.0	EP306L2	--	160L-4	NO !	PAGE 120
29.0	4650	3.04	48.3	22.0	EP310L2	--	160L-4	OK	PAGE 150
29.6	4409	1.17	47.4	20.0	--	EP309R3	160L-4	OK	PAGE 140
29.6	4409	1.47	47.4	20.0	--	EP307R3	160L-4	OK	PAGE 130
31.0	4199	2.64	45.1	20.0	--	EP310R3	160L-4	OK	PAGE 150
32.6	3999	1.35	43.0	14.0	--	EP306R3	160L-4	NO !	PAGE 120
32.9	3961	2.46	42.5	11.0	EP309L3	--	160L-4	NO !	PAGE 140
33.0	4086	1.82	42.5	18.0	EP307L2	--	160L-4	OK	PAGE 130
33.0	4086	2.38	42.5	18.0	EP309L2	--	160L-4	OK	PAGE 140
33.9	3849	1.29	41.3	20.0	--	EP309R3	160L-4	OK	PAGE 140
34.9	3858	0.85	40.1	9.0	EP305L2	--	160L-4	NO !	PAGE 110

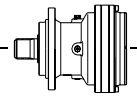

EP300 series gear motor

P1=15KW n1=1400 min⁻¹

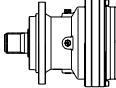
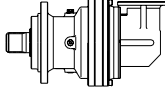
n₂ (min ⁻¹)	M₂ (N.m)	S	I I:	P_t (KW)			IEC Motor type	Check Thermal Power Pt >= P1	Dimension Page Number
35.3	3687	2.64	39.6	20.0	--	EP310R3	160L-4	OK	PAGE 150
35.5	3794	1.25	39.4	13.0	EP306L2	--	160L-4	NO !	PAGE 120
38.8	3359	1.58	36.1	14.0	--	EP306R3	160L-4	NO !	PAGE 120
39.1	3443	2.10	35.8	18.0	EP307L2	--	160L-4	OK	PAGE 130
39.1	3443	3.23	35.8	18.0	EP309L2	--	160L-4	OK	PAGE 140
43.4	3100	1.36	32.2	13.0	EP306L2	--	160L-4	NO !	PAGE 120
43.5	2999	1.47	32.2	20.0	--	EP309R3	160L-4	OK	PAGE 140
43.5	2999	1.76	32.2	20.0	--	EP307R3	160L-4	OK	PAGE 130
43.6	3091	1.02	32.1	9.0	EP305L2	--	160L-4	NO !	PAGE 110
46.7	2885	1.11	30.0	9.0	EP305L2	--	160L-4	NO !	PAGE 110
47.9	2813	2.55	29.3	18.0	EP307L2	--	160L-4	OK	PAGE 130
47.9	2813	3.40	29.3	18.0	EP309L2	--	160L-4	OK	PAGE 140
48.4	2782	1.48	28.9	13.0	EP306L2	--	160L-4	NO !	PAGE 120
48.5	2774	1.13	28.8	9.0	EP305L2	--	160L-4	NO !	PAGE 110
50.6	2575	2.05	27.7	14.0	--	EP306R3	160L-4	NO !	PAGE 120
53.3	2525	2.84	26.3	18.0	EP307L2	--	160L-4	OK	PAGE 130
53.3	2525	3.40	26.3	18.0	EP309L2	--	160L-4	OK	PAGE 140
55.6	2424	1.25	25.2	9.0	EP305L2	--	160L-4	NO !	PAGE 110
56.7	2376	1.70	24.7	13.0	EP306L2	--	160L-4	NO !	PAGE 120
57.8	2330	1.25	24.2	9.0	EP305L2	--	160L-4	NO !	PAGE 110
59.4	2268	2.38	23.6	35.0	--	EP307R2	160L-4	OK	PAGE 130
59.4	2268	2.55	23.6	35.0	--	EP309R2	160L-4	OK	PAGE 140
63.6	2116	3.12	22.0	18.0	EP307L2	--	160L-4	OK	PAGE 130
63.6	2116	3.40	22.0	18.0	EP309L2	--	160L-4	OK	PAGE 140
66.8	2015	2.27	21.0	13.0	EP306L2	--	160L-4	NO !	PAGE 120
70.4	1911	2.55	19.9	35.0	--	EP307R2	160L-4	OK	PAGE 130
70.4	1911	2.55	19.9	35.0	--	EP309R2	160L-4	OK	PAGE 140
75.0	1795	1.42	18.7	9.0	EP305L2	--	160L-4	NO !	PAGE 110
75.8	1777	3.40	18.5	18.0	EP307L2	--	160L-4	OK	PAGE 130
75.8	1777	3.40	18.5	18.0	EP309L2	--	160L-4	OK	PAGE 140
77.0	1747	1.99	18.2	18.0	--	EP306R2	160L-4	OK	PAGE 120
79.5	1693	2.27	17.6	13.0	EP306L2	--	160L-4	NO !	PAGE 120
84.0	1602	2.84	16.7	35.0	--	EP307R2	160L-4	OK	PAGE 130
84.0	1602	2.84	16.7	35.0	--	EP309R2	160L-4	OK	PAGE 140
86.8	1552	3.40	16.1	18.0	EP307L2	--	160L-4	OK	PAGE 130
86.8	1552	3.40	16.1	18.0	EP309L2	--	160L-4	OK	PAGE 140
86.8	1552	3.40	16.1	18.0	EP309L2	--	160L-4	OK	PAGE 140
94.4	1426	1.99	14.8	18.0	--	EP306R2	160L-4	OK	PAGE 120
98.1	1373	1.07	14.3	18.0	--	EP303R2	160L-4	OK	PAGE 100
98.1	1373	1.07	14.3	18.0	--	EP305R2	160L-4	OK	PAGE 110
98.5	1367	1.70	14.2	9.0	EP305L2	--	160L-4	NO !	PAGE 110
104	1298	2.27	13.5	13.0	EP306L2	--	160L-4	NO !	PAGE 120
108	1248	3.40	13.0	35.0	--	EP309R2	160L-4	OK	PAGE 140
109	1232	1.53	12.8	18.0	--	EP303R2	160L-4	OK	PAGE 100
109	1232	1.53	12.8	18.0	--	EP305R2	160L-4	OK	PAGE 110
111	1218	1.99	12.7	18.0	--	EP306R2	160L-4	OK	PAGE 120
111	1209	3.40	12.6	18.0	EP307L2	--	160L-4	OK	PAGE 130
111	1209	3.40	12.6	18.0	EP309L2	--	160L-4	OK	PAGE 140
113	1194	1.70	12.4	9.0	EP305L2	--	160L-4	NO !	PAGE 110
130	1035	1.99	10.8	18.0	--	EP303R2	160L-4	OK	PAGE 100
130	1035	1.99	10.8	18.0	--	EP305R2	160L-4	OK	PAGE 110

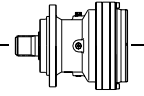

EP300 series gear motor

P1=15KW n1=1400 min⁻¹

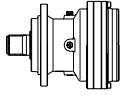
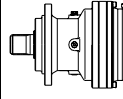
n₂ (min ⁻¹)	M₂ (N.m)	S	I 1:	P_t (KW)			IEC Motor type	Check Thermal Power Pt >= P1	Dimension Page Number
130	1033	1.99	10.7	18.0	--	EP306R2	160L-4	OK	PAGE 120
148	907	1.99	9.4	18.0	--	EP306R2	160L-4	OK	PAGE 120
149	904	1.99	9.4	18.0	--	EP303R2	160L-4	OK	PAGE 100
149	904	1.99	9.4	18.0	--	EP305R2	160L-4	OK	PAGE 110
205	677	1.98	6.8	11.0	EP303L1	--	160L-4	NO !	PAGE 100
205	677	2.75	6.8	13.0	EP305L1	--	160L-4	NO !	PAGE 110
251	553	2.20	5.6	11.0	EP303L1	--	160L-4	NO !	PAGE 100
251	553	3.30	5.6	13.0	EP305L1	--	160L-4	NO !	PAGE 110
280	496	2.20	5.0	11.0	EP303L1	--	160L-4	NO !	PAGE 100
280	496	2.20	5.0	11.0	EP303L1	--	160L-4	NO !	PAGE 100
280	496	3.30	5.0	13.0	EP305L1	--	160L-4	NO !	PAGE 110
333	417	2.20	4.2	11.0	EP303L1	--	160L-4	NO !	PAGE 100
333	417	3.30	4.2	13.0	EP305L1	--	160L-4	NO !	PAGE 110
382	364	2.20	3.7	11.0	EP303L1	--	160L-4	NO !	PAGE 100
382	364	3.30	3.7	13.0	EP305L1	--	160L-4	NO !	PAGE 110

EP300 series gear motor

P1=18.5KW n1=1400 min⁻¹

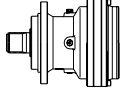
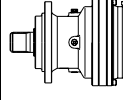
n₂ (min ⁻¹)	M₂ (N.m)	S	I 1:	P_t (KW)			IEC Motor type	Check Thermal Power Pt >= P1	Dimension Page Number
1.2	130021	0.88	1171	18.0	EP316L4	--	180M-4	NO !	PAGE 190
1.4	108970	1.08	981	18.0	EP316L4	--	180M-4	NO !	PAGE 190
1.7	91817	1.23	827	18.0	EP316L4	--	180M-4	NO !	PAGE 190
1.8	85679	1.38	772	45.0	--	EP316R4	180M-4	OK	PAGE 190
2.0	78746	1.03	709	18.0	EP315L4	--	180M-4	NO !	PAGE 180
2.1	75028	1.47	676	18.0	EP316L4	--	180M-4	NO !	PAGE 190
2.2	72223	1.03	650	40.0	--	EP315R4	180M-4	OK	PAGE 180
2.2	72193	1.62	650	45.0	--	EP316R4	180M-4	OK	PAGE 190
2.2	70670	1.13	636	18.0	EP315L4	--	180M-4	NO !	PAGE 180
2.3	67333	1.67	606	18.0	EP316L4	--	180M-4	NO !	PAGE 190
2.6	60504	1.97	545	45.0	--	EP316R4	180M-4	OK	PAGE 190
2.6	60354	1.28	544	18.0	EP315L4	--	180M-4	NO !	PAGE 180
2.6	58930	1.13	531	40.0	--	EP315R4	180M-4	OK	PAGE 180
2.8	56431	1.97	508	18.0	EP316L4	--	180M-4	NO !	PAGE 190
3.0	52200	0.86	470	22.0	--	EP313R4	180M-4	OK	PAGE 170
3.0	51288	1.28	462	40.0	--	EP315R4	180M-4	OK	PAGE 180
3.0	51185	1.47	461	18.0	EP315L4	--	180M-4	NO !	PAGE 180
3.0	50980	2.21	459	45.0	--	EP316R4	180M-4	OK	PAGE 190
3.3	47402	2.31	427	18.0	EP316L4	--	180M-4	NO !	PAGE 190
3.5	43972	2.51	396	18.0	EP316L4	--	180M-4	NO !	PAGE 190
3.6	43215	1.57	389	40.0	--	EP315R4	180M-4	OK	PAGE 180
3.6	42995	1.72	387	18.0	EP315L4	--	180M-4	NO !	PAGE 180
3.6	42726	2.56	385	45.0	--	EP316R4	180M-4	OK	PAGE 190
3.6	42655	1.03	384	22.0	--	EP313R4	180M-4	OK	PAGE 170
4.1	38280	1.13	345	22.0	--	EP313R4	180M-4	OK	PAGE 170
4.2	37458	2.46	337	18.0	EP315L4	--	180M-4	NO !	PAGE 180
4.2	36937	2.95	333	18.0	EP316L4	--	180M-4	NO !	PAGE 190

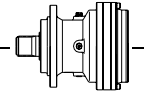

EP300 series gear motor

P1=18.5KW n1=1400 min⁻¹

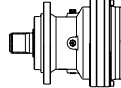
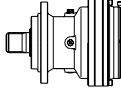
n₂ (min ⁻¹)	M₂ (N.m)	S	I I:	P_t (KW)			IEC Motor type	Check Thermal Power Pt >= P1	Dimension Page Number
4.3	36218	2.11	326	40.0	--	EP315R4	180M-4	OK	PAGE 180
4.4	34956	0.91	315	22.0	--	EP311R4	180M-4	OK	PAGE 160
4.6	34590	1.77	301	30.0	EP315L3	--	180M-4	OK	PAGE 180
4.7	33293	2.95	300	45.0	--	EP316R4	180M-4	OK	PAGE 190
4.8	32246	2.95	290	18.0	EP316L4	--	180M-4	NO !	PAGE 190
4.8	32082	1.33	289	22.0	--	EP313R4	180M-4	OK	PAGE 170
5.0	31371	1.01	283	22.0	--	EP311R4	180M-4	OK	PAGE 160
5.0	30932	2.46	279	40.0	--	EP315R4	180M-4	OK	PAGE 180
5.4	29644	1.47	258	18.0	EP313L3	--	180M-4	NO !	PAGE 170
5.5	29146	2.33	254	30.0	EP315L3	--	180M-4	OK	PAGE 180
5.8	26949	1.52	243	22.0	--	EP313R4	180M-4	OK	PAGE 170
5.9	26292	1.13	237	22.0	--	EP311R4	180M-4	OK	PAGE 160
5.9	26232	2.95	236	40.0	--	EP315R4	180M-4	OK	PAGE 180
6.2	25127	2.95	226	18.0	EP316L4	--	180M-4	NO !	PAGE 190
6.3	25610	1.05	223	18.0	EP311L3	--	180M-4	NO !	PAGE 160
6.4	25000	1.71	218	18.0	EP313L3	--	180M-4	NO !	PAGE 170
6.6	23527	1.72	212	22.0	--	EP313R4	180M-4	OK	PAGE 170
6.8	23781	2.77	207	30.0	EP315L3	--	180M-4	OK	PAGE 180
6.9	23404	2.77	204	30.0	EP316L3	--	180M-4	OK	PAGE 190
7.0	22085	1.28	199	22.0	--	EP311R4	180M-4	OK	PAGE 160
7.1	22035	3.44	198	40.0	--	EP315R4	180M-4	OK	PAGE 180
7.1	22648	0.90	197	18.0	EP310L3	--	180M-4	NO !	PAGE 150
7.4	21033	1.72	189	22.0	--	EP313R4	180M-4	OK	PAGE 170
7.4	21579	1.19	188	18.0	EP311L3	--	180M-4	NO !	PAGE 160
7.6	21065	1.90	183	18.0	EP313L3	--	180M-4	NO !	PAGE 170
7.8	20697	3.05	180	30.0	EP315L3	--	180M-4	OK	PAGE 180
8.1	19281	1.43	174	22.0	--	EP311R4	180M-4	OK	PAGE 160
8.2	19720	3.05	172	30.0	EP316L3	--	180M-4	OK	PAGE 190
8.5	18363	1.72	165	22.0	--	EP313R4	180M-4	OK	PAGE 170
8.7	18507	1.05	161	18.0	EP310L3	--	180M-4	NO !	PAGE 150
9.0	17209	1.57	155	22.0	--	EP311R4	180M-4	OK	PAGE 160
9.1	17633	1.33	154	18.0	EP311L3	--	180M-4	NO !	PAGE 160
9.3	17213	2.14	150	18.0	EP313L3	--	180M-4	NO !	PAGE 170
9.7	16609	1.14	145	18.0	EP310L3	--	180M-4	NO !	PAGE 150
9.8	16459	1.90	143	40.0	--	EP313R3	180M-4	OK	PAGE 170
10.2	15825	1.43	138	18.0	EP311L3	--	180M-4	NO !	PAGE 160
10.4	15448	2.38	135	18.0	EP313L3	--	180M-4	NO !	PAGE 170
10.9	14308	1.72	129	22.0	--	EP313R4	180M-4	OK	PAGE 170
11.3	14226	0.95	124	20.0	--	EP310R3	180M-4	OK	PAGE 150
11.3	14220	1.66	124	40.0	--	EP311R3	180M-4	OK	PAGE 160
11.3	14184	1.33	124	18.0	EP310L3	--	180M-4	NO !	PAGE 150
11.6	13881	2.14	121	40.0	--	EP313R3	180M-4	OK	PAGE 170
12.1	13262	1.66	116	18.0	EP311L3	--	180M-4	NO !	PAGE 160
12.4	12947	2.61	113	18.0	EP313L3	--	180M-4	NO !	PAGE 170
13.1	12242	1.09	107	11.0	EP309L3	--	180M-4	NO !	PAGE 140
13.4	12029	1.52	105	18.0	EP310L3	--	180M-4	NO !	PAGE 150
13.4	11981	1.90	104	40.0	--	EP311R3	180M-4	OK	PAGE 160
13.7	11696	2.38	102	40.0	--	EP313R3	180M-4	OK	PAGE 170
13.8	11607	1.14	101	20.0	--	EP310R3	180M-4	OK	PAGE 150
14.4	11140	1.81	97.0	18.0	EP311L3	--	180M-4	NO !	PAGE 160
14.8	10875	2.61	94.7	18.0	EP313L3	--	180M-4	NO !	PAGE 170

EP300 series gear motor

P1=18.5KW n1=1400 min⁻¹

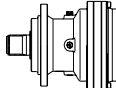
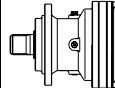
n₂ (min ⁻¹)	M₂ (N.m)	S	I I₁	P_t (KW)			IEC Motor type	Check Thermal Power Pt >= P1	Dimension Page Number
15.9	10105	1.76	88.0	18.0	EP310L3	--	180M-4	NO !	PAGE 150
16.0	10042	2.14	87.5	40.0	--	EP311R3	180M-4	OK	PAGE 160
16.2	9913	1.28	86.3	20.0	--	EP310R3	180M-4	OK	PAGE 150
16.4	9803	2.85	85.4	40.0	--	EP313R3	180M-4	OK	PAGE 170
16.5	9726	2.00	84.7	18.0	EP311L3	--	180M-4	NO !	PAGE 160
16.9	9494	2.76	82.7	18.0	EP313L3	--	180M-4	NO !	PAGE 170
17.0	9431	0.95	82.1	11.0	EP307L3	--	180M-4	NO !	PAGE 130
17.0	9431	1.33	82.1	11.0	EP309L3	--	180M-4	NO !	PAGE 140
18.5	8681	2.19	75.6	18.0	EP311L3	--	180M-4	NO !	PAGE 160
18.7	8607	0.86	75.0	20.0	--	EP307R3	180M-4	OK	PAGE 130
18.9	8512	1.57	74.1	20.0	--	EP310R3	180M-4	OK	PAGE 150
18.9	8488	2.00	73.9	18.0	EP310L3	--	180M-4	NO !	PAGE 150
18.9	8488	2.85	73.9	18.0	EP313L3	--	180M-4	NO !	PAGE 170
20.5	7825	2.38	68.1	40.0	--	EP311R3	180M-4	OK	PAGE 160
20.8	7724	0.95	67.3	20.0	--	EP307R3	180M-4	OK	PAGE 130
21.0	7651	2.85	66.6	40.0	--	EP313R3	180M-4	OK	PAGE 170
21.2	7579	2.38	66.0	18.0	EP311L3	--	180M-4	NO !	PAGE 160
21.7	7410	3.09	64.5	18.0	EP313L3	--	180M-4	NO !	PAGE 170
22.1	7270	1.76	63.3	20.0	--	EP310R3	180M-4	OK	PAGE 150
22.4	7182	1.19	62.5	11.0	EP307L3	--	180M-4	NO !	PAGE 130
22.4	7182	1.57	62.5	11.0	EP309L3	--	180M-4	NO !	PAGE 140
24.7	6507	2.38	56.7	18.0	EP310L3	--	180M-4	NO !	PAGE 150
24.8	6473	1.05	56.4	20.0	--	EP307R3	180M-4	OK	PAGE 130
25.6	6270	1.33	54.6	11.0	EP307L3	--	180M-4	NO !	PAGE 130
25.6	6270	1.71	54.6	11.0	EP309L3	--	180M-4	NO !	PAGE 140
26.1	6165	1.95	53.7	20.0	--	EP310R3	180M-4	OK	PAGE 150
26.4	6097	2.85	53.1	40.0	--	EP311R3	180M-4	OK	PAGE 160
27.2	5905	2.85	51.4	18.0	EP311L3	--	180M-4	NO !	PAGE 160
27.6	5816	0.90	50.6	14.0	--	EP306R3	180M-4	NO !	PAGE 120
29.0	5735	2.47	48.3	22.0	EP310L2	--	180M-4	OK	PAGE 150
29.6	5438	1.19	47.4	20.0	--	EP307R3	180M-4	OK	PAGE 130
31.0	5179	2.14	45.1	20.0	--	EP310R3	180M-4	OK	PAGE 150
32.6	4932	1.09	43.0	14.0	--	EP306R3	180M-4	NO !	PAGE 120
32.9	4886	2.00	42.5	11.0	EP309L3	--	180M-4	NO !	PAGE 140
33.0	5039	1.47	42.5	18.0	EP307L2	--	180M-4	NO !	PAGE 130
33.0	5039	1.93	42.5	18.0	EP309L2	--	180M-4	NO !	PAGE 140
33.9	4747	1.05	41.3	20.0	--	EP309R3	180M-4	OK	PAGE 140
35.3	4548	2.14	39.6	20.0	--	EP310R3	180M-4	OK	PAGE 150
35.5	4679	2.95	39.4	22.0	EP310L2	--	180M-4	OK	PAGE 150
38.8	4143	1.28	36.1	14.0	--	EP306R3	180M-4	NO !	PAGE 120
39.1	4246	1.70	35.8	18.0	EP307L2	--	180M-4	NO !	PAGE 130
39.1	4246	2.62	35.8	18.0	EP309L2	--	180M-4	NO !	PAGE 140
43.5	3699	1.19	32.2	20.0	--	EP309R3	180M-4	OK	PAGE 140
43.5	3699	1.43	32.2	20.0	--	EP307R3	180M-4	OK	PAGE 130
47.9	3469	2.07	29.3	18.0	EP307L2	--	180M-4	NO !	PAGE 130
47.9	3469	2.76	29.3	18.0	EP309L2	--	180M-4	NO !	PAGE 140
50.6	3176	1.66	27.7	14.0	--	EP306R3	180M-4	NO !	PAGE 120
53.3	3114	2.30	26.3	18.0	EP307L2	--	180M-4	NO !	PAGE 130
53.3	3114	2.76	26.3	18.0	EP309L2	--	180M-4	NO !	PAGE 140
59.4	2798	1.93	23.6	35.0	--	EP307R2	180M-4	OK	PAGE 130
59.4	2798	2.07	23.6	35.0	--	EP309R2	180M-4	OK	PAGE 140

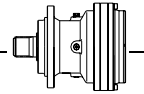

EP300 series gear motor

P1=18.5KW n1=1400 min⁻¹

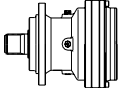
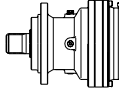
n₂ (min ⁻¹)	M₂ (N.m)	S	I I:	P_t (KW)			IEC Motor type	Check Thermal Power Pt >= P1	Dimension Page Number
63.6	2609	2.53	22.0	18.0	EP307L2	--	180M-4	NO !	PAGE 130
63.6	2609	2.76	22.0	18.0	EP309L2	--	180M-4	NO !	PAGE 140
70.4	2357	2.07	19.9	35.0	--	EP307R2	180M-4	OK	PAGE 130
70.4	2357	2.07	19.9	35.0	--	EP309R2	180M-4	OK	PAGE 140
75.8	2192	2.76	18.5	18.0	EP307L2	--	180M-4	NO !	PAGE 130
75.8	2192	2.76	18.5	18.0	EP309L2	--	180M-4	NO !	PAGE 140
77.0	2155	1.61	18.2	18.0	--	EP306R2	180M-4	NO !	PAGE 120
84.0	1976	2.30	16.7	35.0	--	EP307R2	180M-4	OK	PAGE 130
84.0	1976	2.30	16.7	35.0	--	EP309R2	180M-4	OK	PAGE 140
86.8	1914	2.76	16.1	18.0	EP307L2	--	180M-4	NO !	PAGE 130
86.8	1914	2.76	16.1	18.0	EP307L2	--	180M-4	NO !	PAGE 130
86.8	1914	2.76	16.1	18.0	EP309L2	--	180M-4	NO !	PAGE 140
94.4	1759	1.61	14.8	18.0	--	EP306R2	180M-4	NO !	PAGE 120
98.1	1693	0.87	14.3	18.0	--	EP303R2	180M-4	NO !	PAGE 100
98.1	1693	0.87	14.3	18.0	--	EP305R2	180M-4	NO !	PAGE 110
108	1540	2.76	13.0	35.0	--	EP307R2	180M-4	OK	PAGE 130
108	1540	2.76	13.0	35.0	--	EP307R2	180M-4	OK	PAGE 130
108	1540	2.76	13.0	35.0	--	EP307R2	180M-4	OK	PAGE 130
108	1540	2.76	13.0	35.0	--	EP307R2	180M-4	OK	PAGE 130
108	1540	2.76	13.0	35.0	--	EP309R2	180M-4	OK	PAGE 140
109	1520	1.24	12.8	18.0	--	EP303R2	180M-4	NO !	PAGE 100
109	1520	1.24	12.8	18.0	--	EP305R2	180M-4	NO !	PAGE 110
111	1502	1.61	12.7	18.0	--	EP306R2	180M-4	NO !	PAGE 120
111	1491	2.76	12.6	18.0	EP307L2	--	180M-4	NO !	PAGE 130
111	1491	2.76	12.6	18.0	EP309L2	--	180M-4	NO !	PAGE 140
130	1277	1.61	10.8	18.0	--	EP303R2	180M-4	NO !	PAGE 100
130	1277	1.61	10.8	18.0	--	EP305R2	180M-4	NO !	PAGE 110
130	1274	1.61	10.7	18.0	--	EP306R2	180M-4	NO !	PAGE 120
148	1119	1.61	9.4	18.0	--	EP306R2	180M-4	NO !	PAGE 120
149	1114	1.61	9.4	18.0	--	EP303R2	180M-4	NO !	PAGE 100
149	1114	1.61	9.4	18.0	--	EP305R2	180M-4	NO !	PAGE 110
197	868	3.12	7.1	18.0	EP306L1	--	180M-4	NO !	PAGE 120
205	835	2.23	6.8	13.0	EP305L1	--	180M-4	NO !	PAGE 110
251	682	2.67	5.6	13.0	EP305L1	--	180M-4	NO !	PAGE 110
280	612	2.67	5.0	13.0	EP305L1	--	180M-4	NO !	PAGE 110
333	514	2.67	4.2	13.0	EP305L1	--	180M-4	NO !	PAGE 110
382	449	2.67	3.7	13.0	EP305L1	--	180M-4	NO !	PAGE 110

EP300 series gear motor

P1=22KW n1=1400 min⁻¹

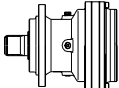
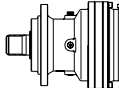
n₂ (min ⁻¹)	M₂ (N.m)	S	I I:	P_t (KW)			IEC Motor type	Check Thermal Power Pt >= P1	Dimension Page Number
1.8	101889	1.16	772	45.0	--	EP316R4	180L-4	OK	PAGE 190
2.2	85887	0.87	650	40.0	--	EP315R4	180L-4	OK	PAGE 180
2.2	85851	1.36	650	45.0	--	EP316R4	180L-4	OK	PAGE 190
2.2	84040	0.95	636	18.0	EP315L4	--	180L-4	NO !	PAGE 180
2.6	71951	1.65	545	45.0	--	EP316R4	180L-4	OK	PAGE 190

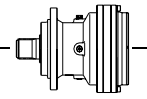

EP300 series gear motor

P1=22KW n1=1400 min⁻¹

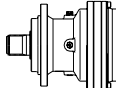
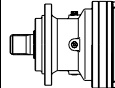
n₂ (min ⁻¹)	M₂ (N.m)	S	I I:	P_t (KW)			IEC Motor type	Check Thermal Power Pt >= P1	Dimension Page Number
2.6	71773	1.07	544	18.0	EP315L4	--	180L-4	NO !	PAGE 180
2.6	70078	0.95	531	40.0	--	EP315R4	180L-4	OK	PAGE 180
3.0	60991	1.07	462	40.0	--	EP315R4	180L-4	OK	PAGE 180
3.0	60868	1.24	461	18.0	EP315L4	--	180L-4	NO !	PAGE 180
3.0	60625	1.86	459	45.0	--	EP316R4	180L-4	OK	PAGE 190
3.6	51391	1.32	389	40.0	--	EP315R4	180L-4	OK	PAGE 180
3.6	51129	1.45	387	18.0	EP315L4	--	180L-4	NO !	PAGE 180
3.6	50810	2.15	385	45.0	--	EP316R4	180L-4	OK	PAGE 190
3.6	50725	0.87	384	22.0	--	EP313R4	180L-4	OK	PAGE 170
4.1	45522	0.95	345	22.0	--	EP313R4	180L-4	OK	PAGE 170
4.2	44545	2.07	337	18.0	EP315L4	--	180L-4	NO !	PAGE 180
4.3	43070	1.78	326	40.0	--	EP315R4	180L-4	OK	PAGE 180
4.6	41134	1.49	301	30.0	EP315L3	--	180L-4	OK	PAGE 180
4.7	39592	2.48	300	45.0	--	EP316R4	180L-4	OK	PAGE 190
4.8	38152	1.12	289	22.0	--	EP313R4	180L-4	OK	PAGE 170
5.0	37306	0.85	283	22.0	--	EP311R4	180L-4	OK	PAGE 160
5.0	36783	2.07	279	40.0	--	EP315R4	180L-4	OK	PAGE 180
5.4	35252	1.24	258	18.0	EP313L3	--	180L-4	NO !	PAGE 170
5.5	34660	1.96	254	30.0	EP315L3	--	180L-4	OK	PAGE 180
5.8	32048	1.28	243	22.0	--	EP313R4	180L-4	OK	PAGE 170
5.9	31266	0.95	237	22.0	--	EP311R4	180L-4	OK	PAGE 160
5.9	31195	2.48	236	40.0	--	EP315R4	180L-4	OK	PAGE 180
6.0	30851	3.10	234	45.0	--	EP316R4	180L-4	OK	PAGE 190
6.3	30455	0.88	223	18.0	EP311L3	--	180L-4	NO !	PAGE 160
6.4	29730	1.44	218	18.0	EP313L3	--	180L-4	NO !	PAGE 170
6.6	27978	1.45	212	22.0	--	EP313R4	180L-4	OK	PAGE 170
6.8	28280	2.33	207	30.0	EP315L3	--	180L-4	OK	PAGE 180
6.9	27831	2.33	204	30.0	EP316L3	--	180L-4	OK	PAGE 190
7.0	26263	1.07	199	22.0	--	EP311R4	180L-4	OK	PAGE 160
7.1	26204	2.89	198	40.0	--	EP315R4	180L-4	OK	PAGE 180
7.4	25013	1.45	189	22.0	--	EP313R4	180L-4	OK	PAGE 170
7.4	25661	1.00	188	18.0	EP311L3	--	180L-4	NO !	PAGE 160
7.6	25050	1.60	183	18.0	EP313L3	--	180L-4	NO !	PAGE 170
7.8	24613	2.56	180	30.0	EP315L3	--	180L-4	OK	PAGE 180
8.1	22928	1.20	174	22.0	--	EP311R4	180L-4	OK	PAGE 160
8.1	22829	3.31	173	40.0	--	EP315R4	180L-4	OK	PAGE 180
8.2	23451	2.56	172	30.0	EP316L3	--	180L-4	OK	PAGE 190
8.5	21837	1.45	165	22.0	--	EP313R4	180L-4	OK	PAGE 170
8.7	22008	0.88	161	18.0	EP310L3	--	180L-4	NO !	PAGE 150
9.0	20465	1.32	155	22.0	--	EP311R4	180L-4	OK	PAGE 160
9.1	20969	1.12	154	18.0	EP311L3	--	180L-4	NO !	PAGE 160
9.2	20739	3.03	152	30.0	EP315L3	--	180L-4	OK	PAGE 180
9.2	20048	3.31	152	40.0	--	EP315R4	180L-4	OK	PAGE 180
9.3	20470	1.80	150	18.0	EP313L3	--	180L-4	NO !	PAGE 170
9.7	19751	0.96	145	18.0	EP310L3	--	180L-4	NO !	PAGE 150
9.8	19573	1.60	143	40.0	--	EP313R3	180L-4	OK	PAGE 170
10.2	18818	1.20	138	18.0	EP311L3	--	180L-4	NO !	PAGE 160
10.4	18370	2.00	135	18.0	EP313L3	--	180L-4	NO !	PAGE 170
10.9	17015	1.45	129	22.0	--	EP313R4	180L-4	OK	PAGE 170
11.3	16989	3.50	124	75.0	--	EP315R3	180L-4	OK	PAGE 180
11.3	16910	1.40	124	40.0	--	EP311R3	180L-4	OK	PAGE 160

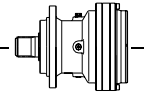

EP300 series gear motor

P1=22KW n1=1400 min⁻¹

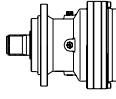
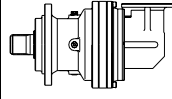
n₂ (min ⁻¹)	M₂ (N.m)	S	I I:	P_t (KW)			IEC Motor type	Check Thermal Power Pt >= P1	Dimension Page Number
11.3	16868	1.12	124	18.0	EP310L3	--	180L-4	NO !	PAGE 150
11.6	16507	1.80	121	40.0	--	EP313R3	180L-4	OK	PAGE 170
12.1	15772	1.40	116	18.0	EP311L3	--	180L-4	NO !	PAGE 160
12.4	15396	2.20	113	18.0	EP313L3	--	180L-4	NO !	PAGE 170
13.4	14305	1.28	105	18.0	EP310L3	--	180L-4	NO !	PAGE 150
13.4	14248	1.60	104	40.0	--	EP311R3	180L-4	OK	PAGE 160
13.7	13909	2.00	102	40.0	--	EP313R3	180L-4	OK	PAGE 170
14.4	13248	1.52	97.0	18.0	EP311L3	--	180L-4	NO !	PAGE 160
14.8	12933	2.20	94.7	18.0	EP313L3	--	180L-4	NO !	PAGE 170
15.9	12016	1.48	88.0	18.0	EP310L3	--	180L-4	NO !	PAGE 150
16.0	11941	1.80	87.5	40.0	--	EP311R3	180L-4	OK	PAGE 160
16.2	11788	1.08	86.3	20.0	--	EP310R3	180L-4	NO !	PAGE 150
16.4	11657	2.40	85.4	40.0	--	EP313R3	180L-4	OK	PAGE 170
16.5	11566	1.68	84.7	18.0	EP311L3	--	180L-4	NO !	PAGE 160
16.9	11290	2.32	82.7	18.0	EP313L3	--	180L-4	NO !	PAGE 170
17.0	11215	1.12	82.1	11.0	EP309L3	--	180L-4	NO !	PAGE 140
18.5	10323	1.84	75.6	18.0	EP311L3	--	180L-4	NO !	PAGE 160
18.9	10122	1.32	74.1	20.0	--	EP310R3	180L-4	NO !	PAGE 150
18.9	10094	1.68	73.9	18.0	EP310L3	--	180L-4	NO !	PAGE 150
18.9	10094	2.40	73.9	18.0	EP313L3	--	180L-4	NO !	PAGE 170
20.5	9305	2.00	68.1	40.0	--	EP311R3	180L-4	OK	PAGE 160
21.0	9098	2.40	66.6	40.0	--	EP313R3	180L-4	OK	PAGE 170
21.2	9012	2.00	66.0	18.0	EP311L3	--	180L-4	NO !	PAGE 160
21.7	8812	2.60	64.5	18.0	EP313L3	--	180L-4	NO !	PAGE 170
22.1	8645	1.48	63.3	20.0	--	EP310R3	180L-4	NO !	PAGE 150
22.4	8541	1.00	62.5	11.0	EP307L3	--	180L-4	NO !	PAGE 130
22.4	8541	1.32	62.5	11.0	EP309L3	--	180L-4	NO !	PAGE 140
24.7	7739	2.00	56.7	18.0	EP310L3	--	180L-4	NO !	PAGE 150
24.8	7698	0.88	56.4	20.0	--	EP307R3	180L-4	NO !	PAGE 130
25.6	7456	1.12	54.6	11.0	EP307L3	--	180L-4	NO !	PAGE 130
25.6	7456	1.44	54.6	11.0	EP309L3	--	180L-4	NO !	PAGE 140
26.1	7331	1.64	53.7	20.0	--	EP310R3	180L-4	NO !	PAGE 150
26.4	7251	2.40	53.1	40.0	--	EP311R3	180L-4	OK	PAGE 160
27.0	7089	2.80	51.9	40.0	--	EP313R3	180L-4	OK	PAGE 170
27.2	7023	2.40	51.4	18.0	EP311L3	--	180L-4	NO !	PAGE 160
27.8	6867	3.20	50.3	18.0	EP313L3	--	180L-4	NO !	PAGE 170
29.0	6819	2.08	48.3	22.0	EP310L2	--	180L-4	OK	PAGE 150
29.6	6466	1.00	47.4	20.0	--	EP307R3	180L-4	NO !	PAGE 130
31.0	6158	1.80	45.1	20.0	--	EP310R3	180L-4	NO !	PAGE 150
32.9	5810	1.68	42.5	11.0	EP309L3	--	180L-4	NO !	PAGE 140
33.0	5992	1.24	42.5	18.0	EP307L2	--	180L-4	NO !	PAGE 130
33.0	5992	1.62	42.5	18.0	EP309L2	--	180L-4	NO !	PAGE 140
35.3	5408	1.80	39.6	20.0	--	EP310R3	180L-4	NO !	PAGE 150
35.5	5564	2.48	39.4	22.0	EP310L2	--	180L-4	OK	PAGE 150
36.1	5476	3.61	38.8	25.0	EP311L2	--	180L-4	OK	PAGE 160
39.1	5049	1.43	35.8	18.0	EP307L2	--	180L-4	NO !	PAGE 130
39.1	5049	2.21	35.8	18.0	EP309L2	--	180L-4	NO !	PAGE 140
41.6	4752	2.93	33.7	22.0	EP310L2	--	180L-4	OK	PAGE 150
43.5	4399	1.00	32.2	20.0	--	EP309R3	180L-4	NO !	PAGE 140
43.5	4399	1.20	32.2	20.0	--	EP307R3	180L-4	NO !	PAGE 130
47.9	4126	1.74	29.3	18.0	EP307L2	--	180L-4	NO !	PAGE 130

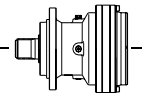

EP300 series gear motor

P1=22KW n1=1400 min⁻¹

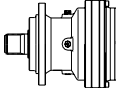
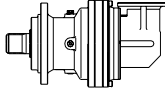
n₂ (min ⁻¹)	M₂ (N.m)	S	I I:	P_t (KW)			IEC Motor type	Check Thermal Power Pt >= P1	Dimension Page Number
47.9	4126	2.32	29.3	18.0	EP309L2	--	180L-4	NO !	PAGE 140
48.4	4080	3.16	28.9	22.0	EP310L2	--	180L-4	OK	PAGE 150
53.3	3703	1.93	26.3	18.0	EP307L2	--	180L-4	NO !	PAGE 130
53.3	3703	2.32	26.3	18.0	EP309L2	--	180L-4	NO !	PAGE 140
56.7	3485	3.38	24.7	22.0	EP310L2	--	180L-4	OK	PAGE 150
59.4	3327	1.62	23.6	35.0	--	EP307R2	180L-4	OK	PAGE 130
59.4	3327	1.74	23.6	35.0	--	EP309R2	180L-4	OK	PAGE 140
63.6	3103	2.13	22.0	18.0	EP307L2	--	180L-4	NO !	PAGE 130
63.6	3103	2.32	22.0	18.0	EP309L2	--	180L-4	NO !	PAGE 140
70.4	2803	1.74	19.9	35.0	--	EP307R2	180L-4	OK	PAGE 130
70.4	2803	1.74	19.9	35.0	--	EP309R2	180L-4	OK	PAGE 140
75.8	2607	2.32	18.5	18.0	EP307L2	--	180L-4	NO !	PAGE 130
75.8	2607	2.32	18.5	18.0	EP309L2	--	180L-4	NO !	PAGE 140
84.0	2350	1.93	16.7	35.0	--	EP307R2	180L-4	OK	PAGE 130
84.0	2350	1.93	16.7	35.0	--	EP309R2	180L-4	OK	PAGE 140
86.8	2276	2.32	16.1	18.0	EP307L2	--	180L-4	NO !	PAGE 130
86.8	2276	2.32	16.1	18.0	EP307L2	--	180L-4	NO !	PAGE 130
86.8	2276	2.32	16.1	18.0	EP309L2	--	180L-4	NO !	PAGE 140
108	1831	2.32	13.0	35.0	--	EP307R2	180L-4	OK	PAGE 130
108	1831	2.32	13.0	35.0	--	EP307R2	180L-4	OK	PAGE 130
108	1831	2.32	13.0	35.0	--	EP307R2	180L-4	OK	PAGE 130
108	1831	2.32	13.0	35.0	--	EP307R2	180L-4	OK	PAGE 130
108	1831	2.32	13.0	35.0	--	EP309R2	180L-4	OK	PAGE 140
111	1773	2.32	12.6	18.0	EP307L2	--	180L-4	NO !	PAGE 130
111	1773	2.32	12.6	18.0	EP309L2	--	180L-4	NO !	PAGE 140
197	1032	2.62	7.1	18.0	EP306L1	--	180L-4	NO !	PAGE 120
242	842	3.28	5.8	18.0	EP306L1	--	180L-4	NO !	PAGE 120
283	719	3.28	4.9	18.0	EP306L1	--	180L-4	NO !	PAGE 120
334	610	3.28	4.2	18.0	EP306L1	--	180L-4	NO !	PAGE 120
380	536	3.28	3.7	18.0	EP306L1	--	180L-4	NO !	PAGE 120

EP300 series gear motor

P1=30KW n1=1400 min⁻¹

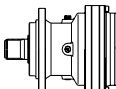
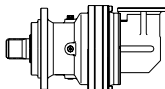
n₂ (min ⁻¹)	M₂ (N.m)	S	I I:	P_t (KW)			IEC Motor type	Check Thermal Power Pt >= P1	Dimension Page Number
1.8	138939	0.85	772	45.0	--	EP316R4	200L-4	OK	PAGE 190
2.2	117069	1.00	650	45.0	--	EP316R4	200L-4	OK	PAGE 190
2.6	98115	1.21	545	45.0	--	EP316R4	200L-4	OK	PAGE 190
3.0	82671	1.36	459	45.0	--	EP316R4	200L-4	OK	PAGE 190
3.6	70078	0.97	389	40.0	--	EP315R4	200L-4	OK	PAGE 180
3.6	69286	1.58	385	45.0	--	EP316R4	200L-4	OK	PAGE 190
4.3	58732	1.30	326	40.0	--	EP315R4	200L-4	OK	PAGE 180
4.6	56092	1.09	301	30.0	EP315L3	--	200L-4	OK	PAGE 180
4.7	53989	1.82	300	45.0	--	EP316R4	200L-4	OK	PAGE 190
5.0	50159	1.52	279	40.0	--	EP315R4	200L-4	OK	PAGE 180
5.5	47263	1.44	254	30.0	EP315L3	--	200L-4	OK	PAGE 180
5.9	42539	1.82	236	40.0	--	EP315R4	200L-4	OK	PAGE 180

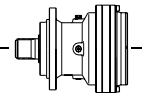

EP300 series gear motor

P1=30KW n1=1400 min⁻¹

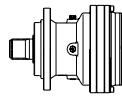
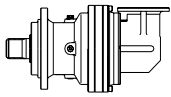
n₂ (min ⁻¹)	M₂ (N.m)	S	I I:	P_t (KW)			IEC Motor type	Check Thermal Power Pt >= P1	Dimension Page Number
6.0	42069	2.27	234	45.0	--	EP316R4	200L-4	OK	PAGE 190
6.8	38564	1.71	207	30.0	EP315L3	--	200L-4	OK	PAGE 180
6.9	37952	1.71	204	30.0	EP316L3	--	200L-4	OK	PAGE 190
7.1	35732	2.12	198	40.0	--	EP315R4	200L-4	OK	PAGE 180
7.8	33563	1.88	180	30.0	EP315L3	--	200L-4	OK	PAGE 180
8.1	31131	2.42	173	40.0	--	EP315R4	200L-4	OK	PAGE 180
8.2	31978	1.88	172	30.0	EP316L3	--	200L-4	OK	PAGE 190
9.2	28280	2.22	152	30.0	EP315L3	--	200L-4	OK	PAGE 180
9.2	27338	2.42	152	40.0	--	EP315R4	200L-4	OK	PAGE 180
9.7	26801	3.08	144	30.0	EP316L3	--	200L-4	OK	PAGE 190
9.8	26691	1.17	143	40.0	--	EP313R3	200L-4	OK	PAGE 170
11.0	23701	2.74	127	30.0	EP315L3	--	200L-4	OK	PAGE 180
11.3	23166	2.56	124	75.0	--	EP315R3	200L-4	OK	PAGE 180
11.3	23059	1.03	124	40.0	--	EP311R3	200L-4	OK	PAGE 160
11.5	22582	3.42	121	30.0	EP316L3	--	200L-4	OK	PAGE 190
11.6	22510	1.32	121	40.0	--	EP313R3	200L-4	OK	PAGE 170
12.9	20242	3.08	109	30.0	EP315L3	--	200L-4	OK	PAGE 180
13.4	19520	3.08	105	75.0	--	EP315R3	200L-4	OK	PAGE 180
13.4	19429	1.17	104	40.0	--	EP311R3	200L-4	OK	PAGE 160
13.7	18967	1.47	102	40.0	--	EP313R3	200L-4	OK	PAGE 170
13.8	18926	3.42	102	30.0	EP316L3	--	200L-4	OK	PAGE 190
15.2	17166	3.42	92.2	30.0	EP315L3	--	200L-4	OK	PAGE 180
16.0	16284	1.32	87.5	40.0	--	EP311R3	200L-4	OK	PAGE 160
16.4	15896	1.76	85.4	40.0	--	EP313R3	200L-4	OK	PAGE 170
17.7	14747	3.42	79	30.0	EP316L3	--	200L-4	OK	PAGE 190
18.1	14420	3.42	77.4	30.0	EP315L3	--	200L-4	OK	PAGE 180
20.5	12689	1.47	68.1	40.0	--	EP311R3	200L-4	OK	PAGE 160
20.8	12563	3.42	67.5	30.0	EP315L3	--	200L-4	OK	PAGE 180
21.0	12407	1.76	66.6	40.0	--	EP313R3	200L-4	OK	PAGE 170
22.7	11492	3.42	62	30.0	EP316L3	--	200L-4	OK	PAGE 190
23.6	11032	3.42	59.2	30.0	EP315L3	--	200L-4	OK	PAGE 180
26.4	9887	1.76	53.1	40.0	--	EP311R3	200L-4	OK	PAGE 160
27.0	9667	2.05	51.9	40.0	--	EP313R3	200L-4	OK	PAGE 170
29.0	9299	1.52	48.3	22.0	EP310L2	--	200L-4	NO !	PAGE 150
33.0	8171	0.91	42.5	18.0	EP307L2	--	200L-4	NO !	PAGE 130
33.0	8171	1.19	42.5	18.0	EP309L2	--	200L-4	NO !	PAGE 140
35.5	7588	1.82	39.4	22.0	EP310L2	--	200L-4	NO !	PAGE 150
36.1	7467	2.65	38.8	25.0	EP311L2	--	200L-4	NO !	PAGE 160
39.1	6885	1.05	35.8	18.0	EP307L2	--	200L-4	NO !	PAGE 130
39.1	6885	1.62	35.8	18.0	EP309L2	--	200L-4	NO !	PAGE 140
41.6	6480	2.15	33.7	22.0	EP310L2	--	200L-4	NO !	PAGE 150
42.8	6292	2.98	32.7	25.0	EP311L2	--	200L-4	NO !	PAGE 160
43.5	5998	0.88	32.2	20.0	--	EP307R3	200L-4	NO !	PAGE 130
47.9	5626	1.28	29.3	18.0	EP307L2	--	200L-4	NO !	PAGE 130
47.9	5626	1.70	29.3	18.0	EP309L2	--	200L-4	NO !	PAGE 140
48.4	5564	2.32	28.9	22.0	EP310L2	--	200L-4	NO !	PAGE 150
50.8	5301	3.31	27.6	25.0	EP311L2	--	200L-4	NO !	PAGE 160
53.3	5049	1.42	26.3	18.0	EP307L2	--	200L-4	NO !	PAGE 130
53.3	5049	1.70	26.3	18.0	EP309L2	--	200L-4	NO !	PAGE 140
56.7	4752	2.48	24.7	22.0	EP310L2	--	200L-4	NO !	PAGE 150
59.4	4537	1.19	23.6	35.0	--	EP307R2	200L-4	OK	PAGE 130

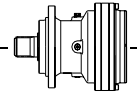

EP300 series gear motor

P1=30KW n1=1400 min⁻¹

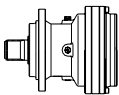
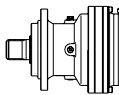
n₂ (min ⁻¹)	M₂ (N.m)	S	I I:	P_t (KW)			IEC Motor type	Check Thermal Power Pt >= P1	Dimension Page Number
59.4	4537	1.28	23.6	35.0	--	EP309R2	200L-4	OK	PAGE 140
60.6	4443	3.31	23.1	25.0	EP311L2	--	200L-4	NO !	PAGE 160
63.6	4232	1.56	22.0	18.0	EP307L2	--	200L-4	NO !	PAGE 130
63.6	4232	1.70	22.0	18.0	EP309L2	--	200L-4	NO !	PAGE 140
66.8	4030	2.65	21.0	22.0	EP310L2	--	200L-4	NO !	PAGE 150
70.4	3823	1.28	19.9	35.0	--	EP307R2	200L-4	OK	PAGE 130
70.4	3823	1.28	19.9	35.0	--	EP309R2	200L-4	OK	PAGE 140
75.8	3555	1.70	18.5	18.0	EP307L2	--	200L-4	NO !	PAGE 130
75.8	3555	1.70	18.5	18.0	EP309L2	--	200L-4	NO !	PAGE 140
77.8	3462	3.31	18.0	25.0	EP311L2	--	200L-4	NO !	PAGE 160
79.5	3385	2.98	17.6	22.0	EP310L2	--	200L-4	NO !	PAGE 150
84.0	3204	1.42	16.7	35.0	--	EP307R2	200L-4	OK	PAGE 130
84.0	3204	1.42	16.7	35.0	--	EP309R2	200L-4	OK	PAGE 140
86.8	3103	1.70	16.1	18.0	EP307L2	--	200L-4	NO !	PAGE 130
86.8	3103	1.70	16.1	18.0	EP307L2	--	200L-4	NO !	PAGE 130
86.8	3103	1.70	16.1	18.0	EP309L2	--	200L-4	NO !	PAGE 140
99.8	2698	3.31	14.0	25.0	EP311L2	--	200L-4	NO !	PAGE 160
108	2497	1.70	13.0	35.0	--	EP307R2	200L-4	OK	PAGE 130
108	2497	1.70	13.0	35.0	--	EP307R2	200L-4	OK	PAGE 130
108	2497	1.70	13.0	35.0	--	EP307R2	200L-4	OK	PAGE 130
108	2497	1.70	13.0	35.0	--	EP307R2	200L-4	OK	PAGE 130
108	2497	1.70	13.0	35.0	--	EP309R2	200L-4	OK	PAGE 140
111	2418	1.70	12.6	18.0	EP307L2	--	200L-4	NO !	PAGE 130
111	2418	1.70	12.6	18.0	EP309L2	--	200L-4	NO !	PAGE 140
225	1237	3.21	6.2	22.0	EP307L1	--	200L-4	NO !	PAGE 130
267	1042	3.21	5.3	22.0	EP307L1	--	200L-4	NO !	PAGE 130
318	873	3.21	4.4	22.0	EP307L1	--	200L-4	NO !	PAGE 130
408	681	3.21	3.4	22.0	EP307L1	--	200L-4	NO !	PAGE 130

EP300 series gear motor

P1=37KW n1=1400 min⁻¹

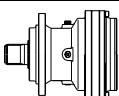
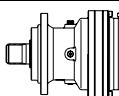
n₂ (min ⁻¹)	M₂ (N.m)	S	I I:	P_t (KW)			IEC Motor type	Check Thermal Power Pt >= P1	Dimension Page Number
2.6	121008	0.98	545	45.0	--	EP316R4	225S-4	OK	PAGE 190
3.0	101961	1.11	459	45.0	--	EP316R4	225S-4	OK	PAGE 190
3.6	85453	1.28	385	45.0	--	EP316R4	225S-4	OK	PAGE 190
4.3	72437	1.06	326	40.0	--	EP315R4	225S-4	OK	PAGE 180
4.6	69181	0.89	301	30.0	EP315L3	--	225S-4	NO !	PAGE 180
4.7	66587	1.47	300	45.0	--	EP316R4	225S-4	OK	PAGE 190
5.0	61863	1.23	279	40.0	--	EP315R4	225S-4	OK	PAGE 180
5.5	58291	1.16	254	30.0	EP315L3	--	225S-4	NO !	PAGE 180
5.9	52464	1.47	236	40.0	--	EP315R4	225S-4	OK	PAGE 180
6.0	51886	1.84	234	45.0	--	EP316R4	225S-4	OK	PAGE 190
6.8	47562	1.39	207	30.0	EP315L3	--	225S-4	NO !	PAGE 180
6.9	46808	1.39	204	30.0	EP316L3	--	225S-4	NO !	PAGE 190
7.1	44070	1.72	198	40.0	--	EP315R4	225S-4	OK	PAGE 180
7.8	41394	1.52	180	30.0	EP315L3	--	225S-4	NO !	PAGE 180

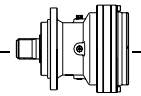

EP300 series gear motor

P1=37KW n1=1400 min⁻¹

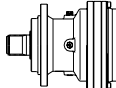
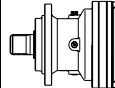
n₂ (min ⁻¹)	M₂ (N.m)	S	I I:	P_t (KW)			IEC Motor type	Check Thermal Power Pt >= P1	Dimension Page Number
8.1	38394	1.97	173	40.0	--	EP315R4	225S-4	OK	PAGE 180
8.2	39440	1.52	172	30.0	EP316L3	--	225S-4	NO !	PAGE 190
9.2	34879	1.80	152	30.0	EP315L3	--	225S-4	NO !	PAGE 180
9.2	33717	1.97	152	40.0	--	EP315R4	225S-4	OK	PAGE 180
9.7	33054	2.49	144	30.0	EP316L3	--	225S-4	NO !	PAGE 190
9.8	32919	0.95	143	40.0	--	EP313R3	225S-4	OK	PAGE 170
11.0	29232	2.22	127	30.0	EP315L3	--	225S-4	NO !	PAGE 180
11.3	28572	2.08	124	75.0	--	EP315R3	225S-4	OK	PAGE 180
11.5	27851	2.77	121	30.0	EP316L3	--	225S-4	NO !	PAGE 190
11.6	27762	1.07	121	40.0	--	EP313R3	225S-4	OK	PAGE 170
12.9	24965	2.49	109	30.0	EP315L3	--	225S-4	NO !	PAGE 180
13.4	24074	2.49	105	75.0	--	EP315R3	225S-4	OK	PAGE 180
13.4	23963	0.95	104	40.0	--	EP311R3	225S-4	OK	PAGE 160
13.7	23392	1.19	102	40.0	--	EP313R3	225S-4	OK	PAGE 170
13.8	23342	2.77	102	30.0	EP316L3	--	225S-4	NO !	PAGE 190
15.2	21172	2.77	92.2	30.0	EP315L3	--	225S-4	NO !	PAGE 180
15.3	20953	2.77	91.2	75.0	--	EP315R3	225S-4	OK	PAGE 180
16.0	20083	1.07	87.5	40.0	--	EP311R3	225S-4	OK	PAGE 160
16.4	19605	1.43	85.4	40.0	--	EP313R3	225S-4	OK	PAGE 170
17.7	18189	2.77	79	30.0	EP316L3	--	225S-4	NO !	PAGE 190
18.1	17784	2.77	77.4	30.0	EP315L3	--	225S-4	NO !	PAGE 180
20.5	15649	1.19	68.1	40.0	--	EP311R3	225S-4	OK	PAGE 160
20.8	15494	2.77	67.5	30.0	EP315L3	--	225S-4	NO !	PAGE 180
21.0	15301	1.43	66.6	40.0	--	EP313R3	225S-4	OK	PAGE 170
22.7	14173	2.77	62	30.0	EP316L3	--	225S-4	NO !	PAGE 190
23.6	13607	2.77	59.2	30.0	EP315L3	--	225S-4	NO !	PAGE 180
26.4	12194	1.43	53.1	40.0	--	EP311R3	225S-4	OK	PAGE 160
26.6	12106	2.77	53	90.0	--	EP316R3	225S-4	OK	PAGE 190
27.0	11923	1.66	51.9	40.0	--	EP313R3	225S-4	OK	PAGE 170
37.0	8982	2.95	37.9	30.0	EP313L2	--	225S-4	NO !	PAGE 170
43.8	7575	3.22	31.9	30.0	EP313L2	--	225S-4	NO !	PAGE 170
52.0	6383	3.49	26.9	30.0	EP313L2	--	225S-4	NO !	PAGE 170
59.4	5596	0.97	23.6	35.0	--	EP307R2	225S-4	NO !	PAGE 130
62.1	5349	3.49	22.6	30.0	EP313L2	--	225S-4	NO !	PAGE 170
70.1	4737	3.49	20.0	55.0	--	EP310R2	225S-4	OK	PAGE 150
70.4	4715	1.04	19.9	35.0	--	EP307R2	225S-4	NO !	PAGE 130
70.4	4715	1.04	19.9	35.0	--	EP309R2	225S-4	NO !	PAGE 140
79.5	4175	3.49	17.6	30.0	EP313L2	--	225S-4	NO !	PAGE 170
84.0	3951	1.15	16.7	35.0	--	EP307R2	225S-4	NO !	PAGE 130
84.0	3951	1.15	16.7	35.0	--	EP309R2	225S-4	NO !	PAGE 140
95.6	3474	3.49	14.6	55.0	--	EP310R2	225S-4	OK	PAGE 150
102	3253	3.49	13.7	30.0	EP313L2	--	225S-4	NO !	PAGE 170
108	3079	1.38	13.0	35.0	--	EP307R2	225S-4	NO !	PAGE 130
108	3079	1.38	13.0	35.0	--	EP307R2	225S-4	NO !	PAGE 130
108	3079	1.38	13.0	35.0	--	EP307R2	225S-4	NO !	PAGE 130
108	3079	1.38	13.0	35.0	--	EP307R2	225S-4	NO !	PAGE 130
108	3079	1.38	13.0	35.0	--	EP309R2	225S-4	NO !	PAGE 140
114	2918	3.49	12.3	55.0	--	EP310R2	225S-4	OK	PAGE 150
225	1525	3.38	6.2	25.0	EP309L1	--	225S-4	NO !	PAGE 140
267	1285	3.38	5.3	25.0	EP309L1	--	225S-4	NO !	PAGE 140
318	1077	3.38	4.4	25.0	EP309L1	--	225S-4	NO !	PAGE 140

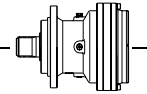

EP300 series gear motor

P1=45KW n1=1400 min⁻¹

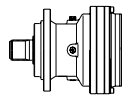
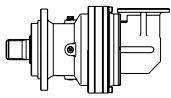
n₂ (min ⁻¹)	M₂ (N.m)	S	I 1:	P_t (KW)			IEC Motor type	Check Thermal Power Pt >= P1	Dimension Page Number
3.0	124006	0.91	459	45.0	--	EP316R4	225M-4	OK	PAGE 190
3.6	103929	1.05	385	45.0	--	EP316R4	225M-4	OK	PAGE 190
4.7	80984	1.21	300	45.0	--	EP316R4	225M-4	OK	PAGE 190
5.9	63808	1.21	236	40.0	--	EP315R4	225M-4	NO !	PAGE 180
6.0	63104	1.52	234	45.0	--	EP316R4	225M-4	OK	PAGE 190
7.1	53599	1.41	198	40.0	--	EP315R4	225M-4	NO !	PAGE 180
8.1	46696	1.62	173	40.0	--	EP315R4	225M-4	NO !	PAGE 180
9.2	41007	1.62	152	40.0	--	EP315R4	225M-4	NO !	PAGE 180
11.3	34750	1.71	124	75.0	--	EP315R3	225M-4	OK	PAGE 180
11.6	33765	0.88	121	40.0	--	EP313R3	225M-4	NO !	PAGE 170
13.4	29280	2.05	105	75.0	--	EP315R3	225M-4	OK	PAGE 180
13.7	28450	0.98	102	40.0	--	EP313R3	225M-4	NO !	PAGE 170
14.6	26757	2.96	96	90.0	--	EP316R3	225M-4	OK	PAGE 190
15.3	25483	2.28	91.2	75.0	--	EP315R3	225M-4	OK	PAGE 180
16.4	23844	1.17	85.4	40.0	--	EP313R3	225M-4	NO !	PAGE 170
17.3	22545	3.42	81	90.0	--	EP316R3	225M-4	OK	PAGE 190
18.2	21472	2.85	76.9	75.0	--	EP315R3	225M-4	OK	PAGE 180
20.7	18895	3.42	68	90.0	--	EP316R3	225M-4	OK	PAGE 190
21.0	18610	1.17	66.6	40.0	--	EP313R3	225M-4	NO !	PAGE 170
21.7	17995	3.42	64.4	75.0	--	EP315R3	225M-4	OK	PAGE 180
25.9	15116	3.42	54.1	75.0	--	EP315R3	225M-4	OK	PAGE 180
26.4	14831	1.17	53.1	40.0	--	EP311R3	225M-4	NO !	PAGE 160
26.6	14724	2.28	53	90.0	--	EP316R3	225M-4	OK	PAGE 190
27.0	14501	1.37	51.9	40.0	--	EP313R3	225M-4	NO !	PAGE 170
29.7	13169	3.42	47.2	75.0	--	EP315R3	225M-4	OK	PAGE 180
70.1	5761	2.87	20.0	55.0	--	EP310R2	225M-4	OK	PAGE 150
73.5	5492	3.31	19.0	75.0	--	EP313R2	225M-4	OK	PAGE 170
76.7	5265	3.31	18.2	75.0	--	EP311R2	225M-4	OK	PAGE 160
83.7	4828	3.31	16.7	75.0	--	EP313R2	225M-4	OK	PAGE 170
91.1	4436	3.31	15.4	75.0	--	EP311R2	225M-4	OK	PAGE 160
95.6	4225	2.87	14.6	55.0	--	EP310R2	225M-4	OK	PAGE 150
114	3549	2.87	12.3	55.0	--	EP310R2	225M-4	OK	PAGE 150
117	3457	3.31	12.0	75.0	--	EP311R2	225M-4	OK	PAGE 160
120	3380	3.31	11.7	75.0	--	EP313R2	225M-4	OK	PAGE 170

P1=55KW n1=1400 min⁻¹

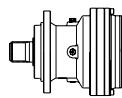
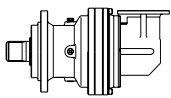
n₂ (min ⁻¹)	M₂ (N.m)	S	I 1:	P_t (KW)			IEC Motor type	Check Thermal Power Pt >= P1	Dimension Page Number
11.3	42472	1.40	124	75.0	--	EP315R3	250M-4	OK	PAGE 180
13.4	35786	1.68	105	75.0	--	EP315R3	250M-4	OK	PAGE 180
14.6	32703	2.42	96	90.0	--	EP316R3	250M-4	OK	PAGE 190
15.3	31146	1.86	91.2	75.0	--	EP315R3	250M-4	OK	PAGE 180
17.3	27556	2.80	81	90.0	--	EP316R3	250M-4	OK	PAGE 190
18.2	26243	2.33	76.9	75.0	--	EP315R3	250M-4	OK	PAGE 180
20.7	23094	2.80	68	90.0	--	EP316R3	250M-4	OK	PAGE 190
21.7	21994	2.80	64.4	75.0	--	EP315R3	250M-4	OK	PAGE 180
25.9	18475	2.80	54.1	75.0	--	EP315R3	250M-4	OK	PAGE 180

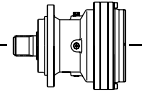

EP300 series gear motor

P1=55KW n1=1400 min⁻¹

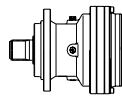
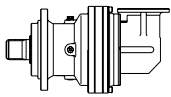
n₂ (min ⁻¹)	M₂ (N.m)	S	I 1:	P_t (KW)			IEC Motor type	Check Thermal Power Pt >= P1	Dimension Page Number
26.6	17995	1.86	53	90.0	--	EP316R3	250M-4	OK	PAGE 190
29.7	16096	2.80	47.2	75.0	--	EP315R3	250M-4	OK	PAGE 180
70.1	7041	2.35	20.0	55.0	--	EP310R2	250M-4	OK	PAGE 150
73.5	6713	2.71	19.0	75.0	--	EP313R2	250M-4	OK	PAGE 170
76.7	6435	2.71	18.2	75.0	--	EP311R2	250M-4	OK	PAGE 160
83.7	5901	2.71	16.7	75.0	--	EP313R2	250M-4	OK	PAGE 170
91.1	5422	2.71	15.4	75.0	--	EP311R2	250M-4	OK	PAGE 160
95.6	5164	2.35	14.6	55.0	--	EP310R2	250M-4	OK	PAGE 150
114	4337	2.35	12.3	55.0	--	EP310R2	250M-4	OK	PAGE 150
117	4225	2.71	12.0	75.0	--	EP311R2	250M-4	OK	PAGE 160
120	4131	2.71	11.7	75.0	--	EP313R2	250M-4	OK	PAGE 170

EP300 series gear motor

P1=75KW n1=1400 min⁻¹

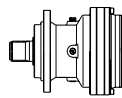
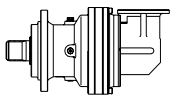
n₂ (min ⁻¹)	M₂ (N.m)	S	I 1:	P_t (KW)			IEC Motor type	Check Thermal Power Pt >= P1	Dimension Page Number
11.3	57916	1.03	124	75.0	--	EP315R3	280S-4	OK	PAGE 180
13.4	48800	1.23	105	75.0	--	EP315R3	280S-4	OK	PAGE 180
14.6	44595	1.78	96	90.0	--	EP316R3	280S-4	OK	PAGE 190
15.3	42472	1.37	91.2	75.0	--	EP315R3	280S-4	OK	PAGE 180
17.3	37576	2.05	81	90.0	--	EP316R3	280S-4	OK	PAGE 190
18.2	35786	1.71	76.9	75.0	--	EP315R3	280S-4	OK	PAGE 180
20.7	31492	2.05	68	90.0	--	EP316R3	280S-4	OK	PAGE 190
21.7	29992	2.05	64.4	75.0	--	EP315R3	280S-4	OK	PAGE 180
25.9	25194	2.05	54.1	75.0	--	EP315R3	280S-4	OK	PAGE 180
26.6	24539	1.37	53	90.0	--	EP316R3	280S-4	OK	PAGE 190
29.7	21949	2.05	47.2	75.0	--	EP315R3	280S-4	OK	PAGE 180
73.5	9154	1.99	19.0	75.0	--	EP313R2	280S-4	OK	PAGE 170
76.7	8774	1.99	18.2	75.0	--	EP311R2	280S-4	OK	PAGE 160
83.7	8047	1.99	16.7	75.0	--	EP313R2	280S-4	OK	PAGE 170
91.1	7393	1.99	15.4	75.0	--	EP311R2	280S-4	OK	PAGE 160
117	5761	1.99	12.0	75.0	--	EP311R2	280S-4	OK	PAGE 160
120	5633	1.99	11.7	75.0	--	EP313R2	280S-4	OK	PAGE 170

EP300 series gear motor

P1=90KW n1=1400 min⁻¹

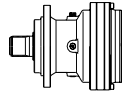
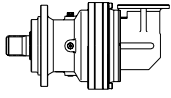
n₂ (min ⁻¹)	M₂ (N.m)	S	I 1:	P_t (KW)			IEC Motor type	Check Thermal Power Pt >= P1	Dimension Page Number
14.6	53514	1.48	96	90.0	--	EP316R3	280M-4	OK	PAGE 190
17.3	45091	1.71	81	90.0	--	EP316R3	280M-4	OK	PAGE 190
20.7	37790	1.71	68	90.0	--	EP316R3	280M-4	OK	PAGE 190
26.6	29447	1.14	53	90.0	--	EP316R3	280M-4	OK	PAGE 190
73.5	10984	1.65	19.0	75.0	--	EP313R2	280M-4	NO !	PAGE 170
83.7	9656	1.65	16.7	75.0	--	EP313R2	280M-4	NO !	PAGE 170
120	6760	1.65	11.7	75.0	--	EP313R2	280M-4	NO !	PAGE 170

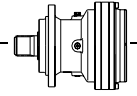

EP300L

M2'=1000N.m

	I	Mn ₂ (N.m)						P ₁ (KW)	P _t (KW) (ta=20°C) (n ₁ =1500)	n ₁ (min ⁻¹)	n _{1max} (min ⁻¹)	M _b (N.m)	Brake type
		n ₂ .h 10000	n ₂ .h 25000	n ₂ .h 50000	n ₂ .h 100000	n ₂ .h 500000	n ₂ .h 1000000						
L1	3.4	1 000	1 000	890	850	760	610	20	7.5	1 750	3 500	400	4K
	4.4	1 000	1 000	890	850	760	610	20	7.5	1 750	3 500	330	4H
	5.8	860	730	650	650	650	580	15	7.5	1 750	3 500	260	4F
	7.2	700	600	550	550	550	510	11	7.5	1 750	3 500	160	4D
L2	11.5	1 000	1 000	890	850	760	610	9	7.5	1 750	3 500	100	4B
	15	1 000	1 000	890	850	760	610	7.5	7.5	1 750	3 500	100	4B
	19.8	1 000	1 000	890	850	760	610	6.2	7.5	1 750	3 500	100	4B
	25.6	1 000	1 000	890	850	760	610	5	7.5	1 750	3 500	100	4B
	32	1 000	1 000	890	850	760	610	4.1	7.5	1 750	3 500	50	4A
	41.5	860	730	650	650	650	580	2.8	7.5	1 750	3 500	50	4A
	51.8	700	600	550	550	550	510	1.9	7.5	1 750	3 500	50	4A
	L3	38.8	1 000	1 000	890	850	760	610	3.5	7.5	1 750	3 500	50
50.9		1 000	1 000	890	850	760	610	2.8	7.5	1 750	3 500	50	4A
66.1		1 000	1 000	890	850	760	610	2.2	7.5	1 750	3 500	50	4A
87.8		1 000	1 000	890	850	760	610	1.7	7.5	1 750	3 500	50	4A
108		1 000	1 000	890	850	760	610	1.4	7.5	1 750	3 500	50	4A
114		1 000	1 000	890	850	760	610	1.3	7.5	1 750	3 500	50	4A
142		1 000	1 000	890	850	760	610	1.1	7.5	1 750	3 500	50	4A
185		1 000	1 000	890	850	760	610	0.85	7.5	1 750	3 500	50	4A
230		1 000	1 000	890	850	760	610	0.7	7.5	1 750	3 500	50	4A
299		860	730	650	650	650	580	0.38	7.5	1 750	3 500	50	4A
373	700	600	550	550	550	510	0.27	7.5	1 750	3 500	50	4A	
L4	297	1 000	1 000	890	850	760	610	0.54	6.0	1 750	3 500	50	4A
	386	1 000	1 000	890	850	760	610	0.42	6.0	1 750	3 500	50	4A
	476	1 000	1 000	890	850	760	610	0.35	6.0	1 750	3 500	50	4A
	501	1 000	1 000	890	850	760	610	0.33	6.0	1 750	3 500	50	4A
	625	1 000	1 000	890	850	760	610	0.27	6.0	1 750	3 500	50	4A
	650	1 000	1 000	890	850	760	610	0.26	6.0	1 750	3 500	50	4A
	780	1 000	1 000	890	850	760	610	0.23	6.0	1 750	3 500	50	4A
	853	1 000	1 000	890	850	760	610	0.21	6.0	1 750	3 500	50	4A
	1024	1 000	1 000	890	850	760	610	0.17	6.0	1 750	3 500	50	4A
	1108	860	730	650	650	650	580	0.12	6.0	1 750	3 500	50	4A
	1329	1 000	1 000	890	850	760	610	0.13	6.0	1 750	3 500	50	4A
	1383	860	730	650	650	650	580	0.11	6.0	1 750	3 500	50	4A
	1659	1 000	1 000	890	850	760	610	0.11	6.0	1 750	3 500	50	4A
	1725	860	730	650	650	650	580	0.09	6.0	1 750	3 500	50	4A
2153	860	730	650	650	650	580	0.07	6.0	1 750	3 500	50	4A	
2687	700	600	550	550	550	510	0.04	6.0	1 750	3 500	50	4A	

$$M_{2max}=1.2 \times Mn_2(n_2 \times h=10\ 000)$$

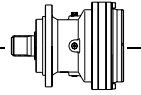

EP300R

M2'=1000N.m

	I 1:	Mn ₂ (N.m)						P ₁ (KW)	P _t (KW) (ta=20°C) (n ₁ =1500)	n ₁ (min ⁻¹)	n _{1max} (min ⁻¹)	M _b (N.m)	Brake type
		n ₂ .h 10000	n ₂ .h 25000	n ₂ .h 50000	n ₂ .h 100000	n ₂ .h 500000	n ₂ .h 1000000						
R2	6.9	1 000	1 000	890	850	760	610	15	12	1 750	3 500	160	4D
	9.1	1 000	1 000	890	850	760	610	15	12	1 750	3 500	160	4D
	11.8	860	730	650	650	650	580	7.5	12	1 750	3 500	100	4B
	14.8	700	600	550	550	550	510	5	12	1 750	3 500	100	4B
R3	23.5	1 000	1 000	890	850	760	610	5	12	1 750	3 500	100	4B
	30.8	1 000	1 000	890	850	760	610	4.2	12	1 750	3 500	50	4A
	40.5	1 000	1 000	890	850	760	610	3.3	12	1 750	3 500	50	4A
	52.6	1 000	1 000	890	850	760	610	2.7	12	1 750	3 500	50	4A
	65.6	1 000	1 000	890	850	760	610	2.2	12	1 750	3 500	50	4A
	85.2	860	730	650	650	650	580	1.3	12	1 750	3 500	50	4A
	106	700	600	550	550	550	510	0.9	12	1 750	3 500	50	4A
R4	79.5	1 000	1 000	890	850	760	610	1.8	10	1 750	3 500	50	4A
	104	1 000	1 000	890	850	760	610	1.4	10	1 750	3 500	50	4A
	135	1 000	1 000	890	850	760	610	1.1	10	1 750	3 500	50	4A
	180	1 000	1 000	890	850	760	610	0.85	10	1 750	3 500	50	4A
	222	1 000	1 000	890	850	760	610	0.7	10	1 750	3 500	50	4A
	234	1 000	1 000	890	850	760	610	0.66	10	1 750	3 500	50	4A
	292	1 000	1 000	890	850	760	610	0.55	10	1 750	3 500	50	4A
	378	1 000	1 000	890	850	760	610	0.42	10	1 750	3 500	50	4A
	472	1 000	1 000	890	850	760	610	0.37	10	1 750	3 500	50	4A
	613	860	730	650	650	650	580	0.21	10	1 750	3 500	50	4A
765	700	600	550	550	550	510	0.14	10	1 750	3 500	50	4A	

M_{2max}=1.2×Mn₂(n₂×h=10 000)

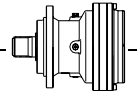

EP300L

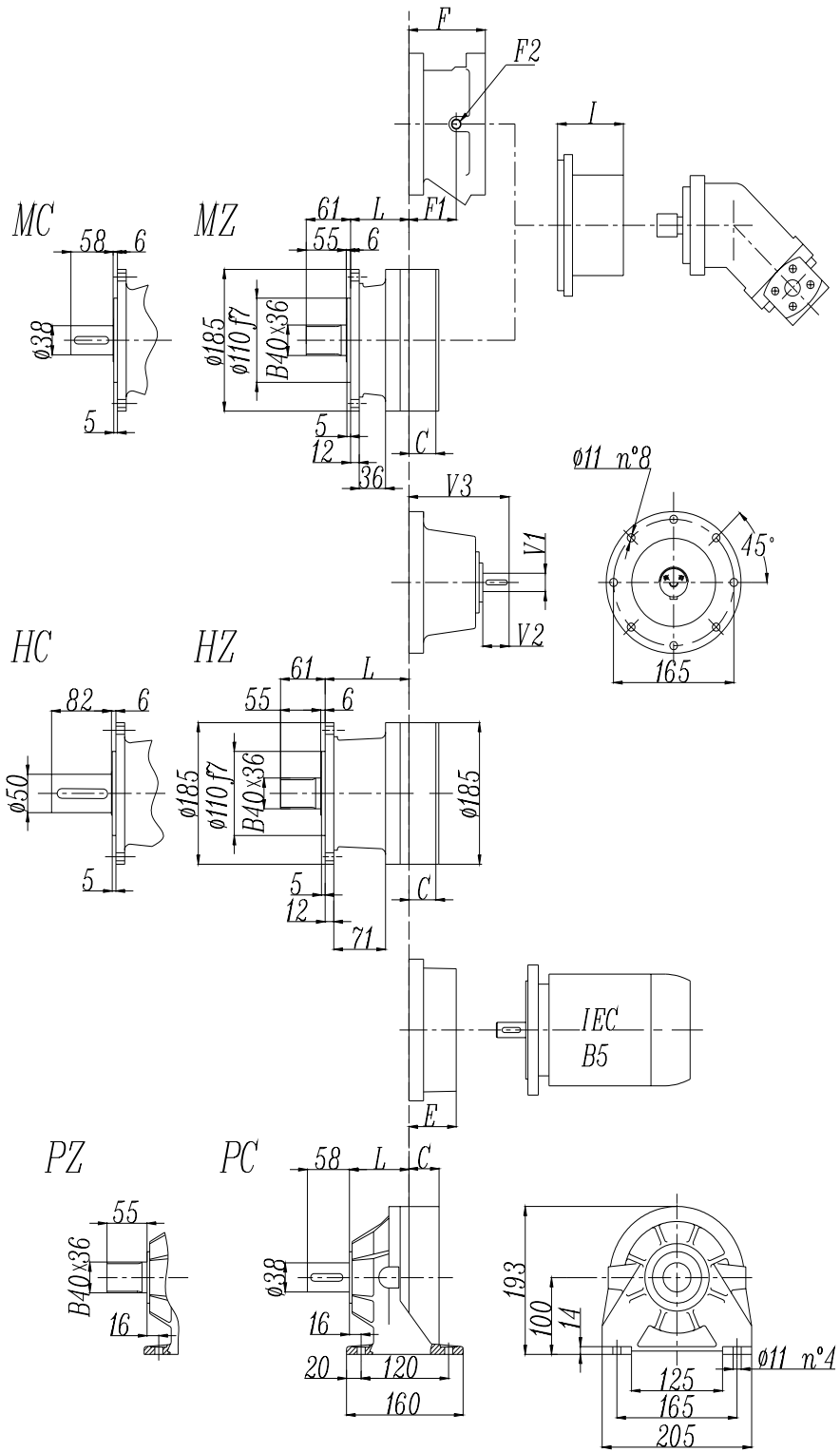

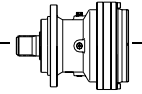

EP300L

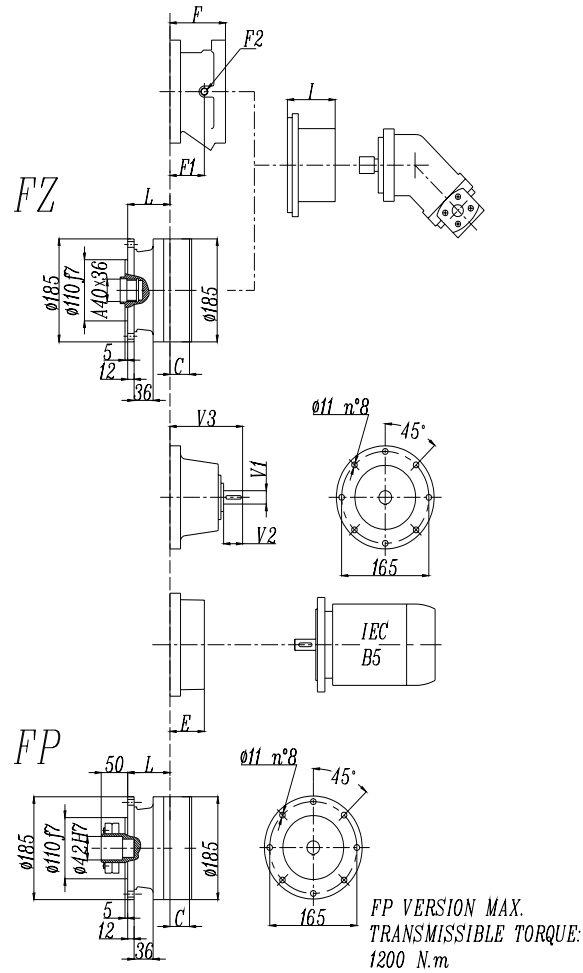

	L				Ref. weight (without input) (Kg)				C	I	Brake				Ref. Weight 15 Kg
	MZ MC	FZ FP	HZ HC	PC PZ	MZ MC	FZ FP	HZ HC	PC PZ			F	F1	F2	Type	
300L1	80	80	115	86	18	16	20	23	37	According to hydraulic motor	105	65	1/4 G	4	
300L2	133	133	168	139	22	20	24	27	37		105	65	1/4 G	4	
300L3	186	186	221	192	26	24	28	31	37		105	65	1/4 G	4	
300L4	239	239	274	245	30	28	32	35	37		105	65	1/4 G	4	

	E (IEC motor input)						
	IEC71	IEC80	IEC90	IEC100	IEC112	IEC132	
300L1	65	84	84	94	94	114	
300L2	65	84	84	94	94	114	
300L3	65	84	84	94	94	114	
300L4	65	84	84	94	94	114	

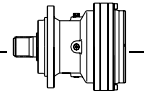

EP300R

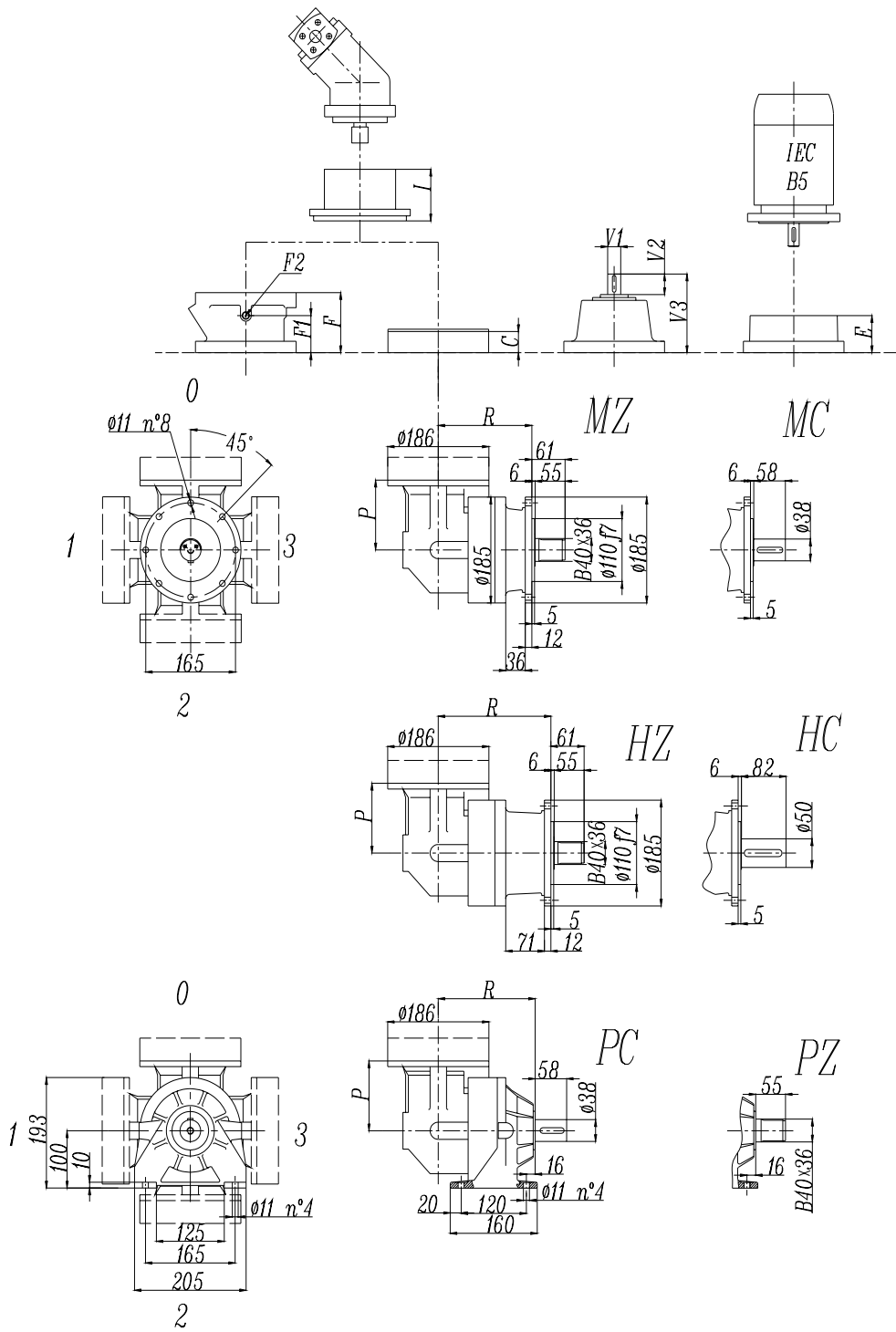

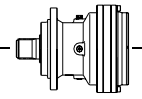

EP300R

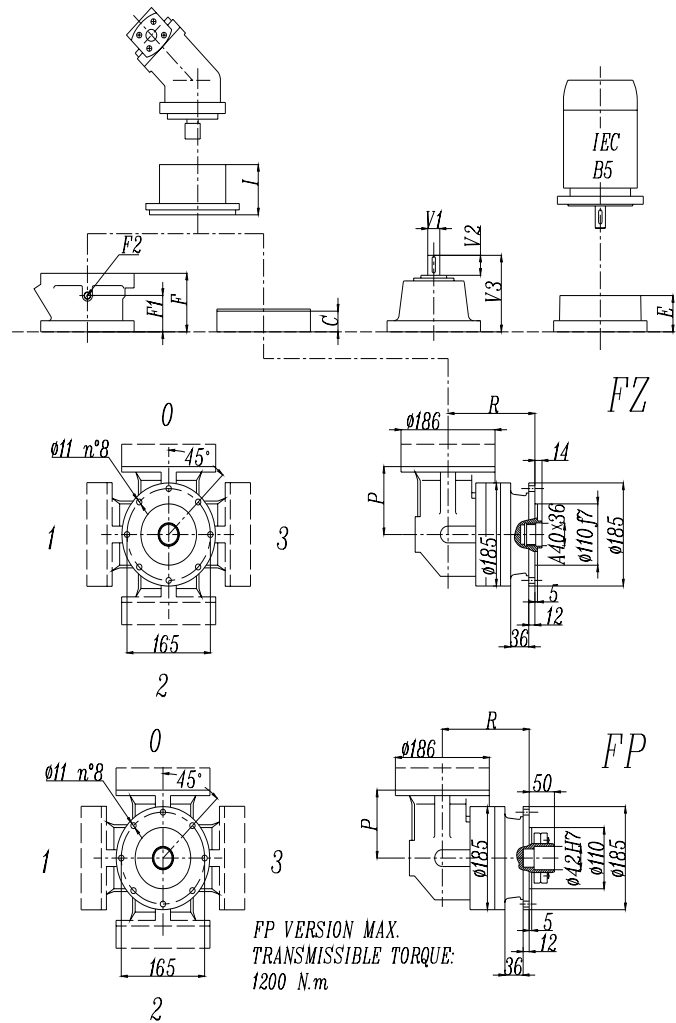

	R				Ref. weight (without input) (Kg)				C	P	I	Brake				
	MZ MC	FZ FP	HZ HC	PC PZ	MZ MC	FZ FP	HZ HC	PC PZ				F	F1	F2	Type	Ref. Weight
300R2	172	172	207	178	32	30	34	37	37	122	According to hydraulic motor	105	65	1/4 G	4	15 Kg
300R3	225	225	260	231	36	34	38	41	37			105	65	1/4 G	4	
300R4	278	278	313	284	40	38	42	45	37			105	65	1/4 G	4	

	E (IEC motor input)						
	IEC71	IEC80	IEC90	IEC100	IEC112	IEC132	
300R2	65	84	84	94	94	114	
300R3	65	84	84	94	94	114	
300R4	65	84	84	94	94	114	

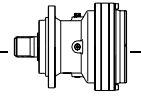

EP300L - EP300R

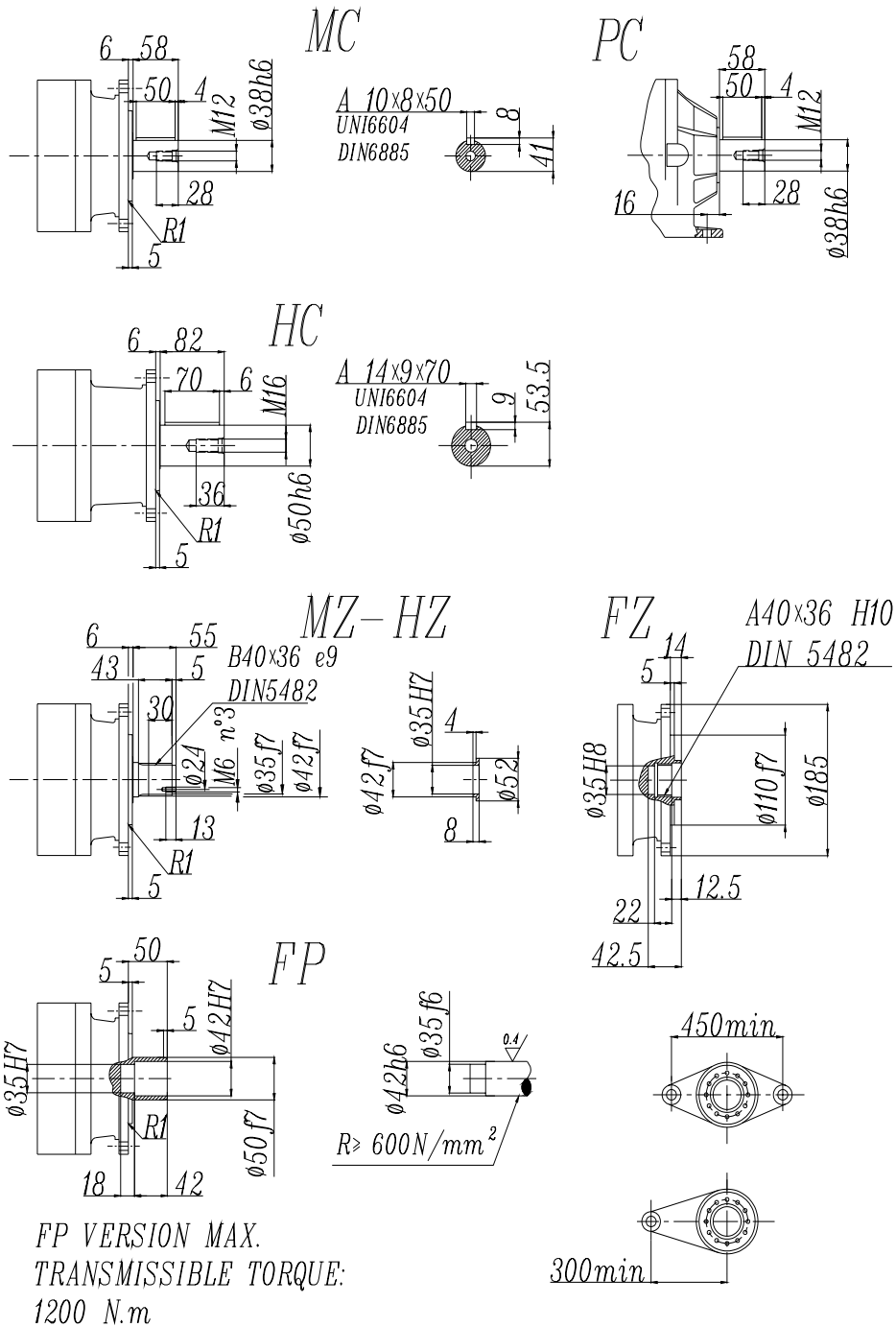

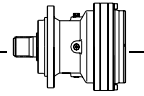

EP300L - EP300R

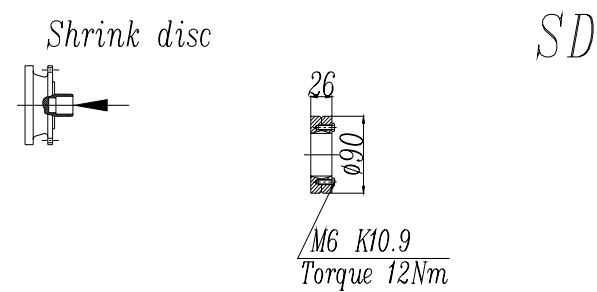
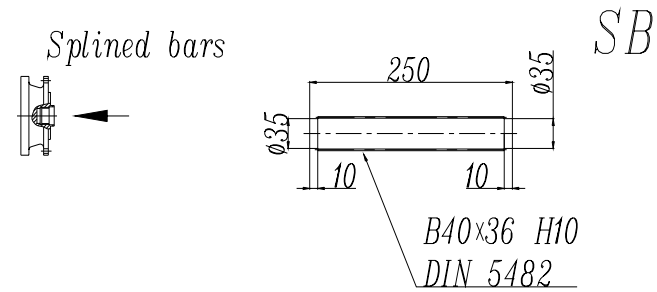
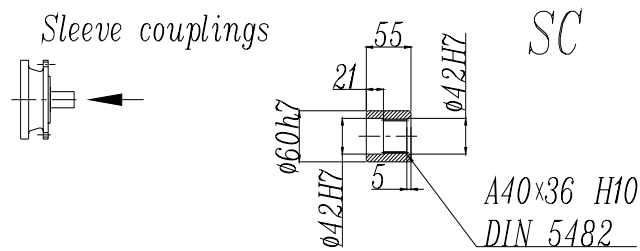
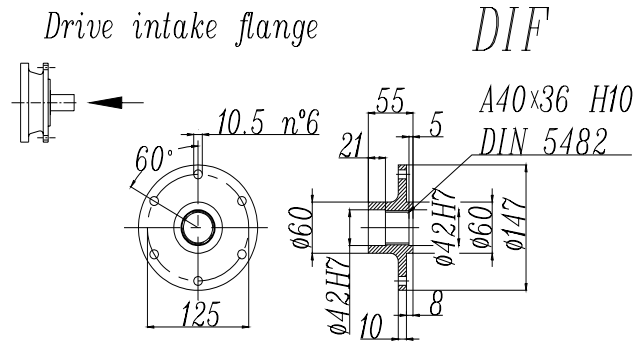

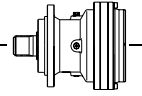

EP300L - EP300R

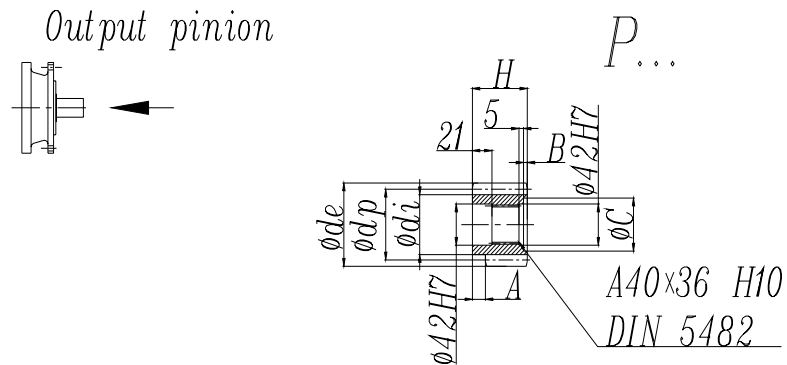

	m	z	x	dp	di	de	H	A	B	C
PBE	4.5	14	0.507	63	56	75.5	55	0	0	0
PCE	5	14	0.500	70	62.5	84.8	65	0	10	53
PDC	6	12	0.250	72	61	84.8	59	14	4	54
PDE	6	14	0.500	84	73	99.6	65	0	10	54

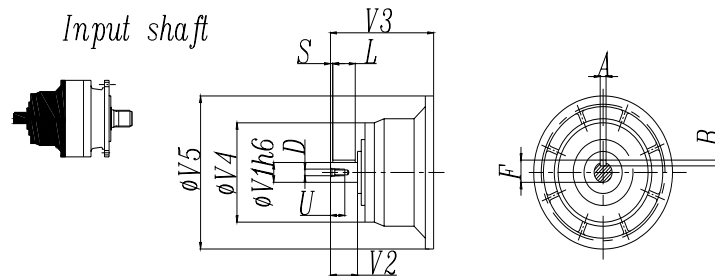

	CODE	V1	V2	V3	V4	V5	A	B	F	L	S	D	U
300L1	V01A	24	36	137.5	120	186	8	7	27	30	3	M8	19
	V01B	38	58	158	120	186	10	8	41	50	4	M12	28
300L2	V01A	24	36	137.5	120	186	8	7	27	30	3	M8	19
	V01B	38	58	158	120	186	10	8	41	50	4	M12	28
300L3	V01A	24	36	137.5	120	186	8	7	27	30	3	M8	19
	V01B	38	58	158	120	186	10	8	41	50	4	M12	28
300L4	V01A	24	36	137.5	120	186	8	7	27	30	3	M8	19
	V01B	38	58	158	120	186	10	8	41	50	4	M12	28
300R2-R3-R4	V01A	24	36	137.5	120	186	8	7	27	30	3	M8	19
	V01B	38	58	158	120	186	10	8	41	50	4	M12	28

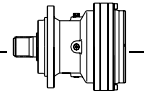

EP300L - EP300R

Permissible radial and axial loads on output shaft with Fh2 ($n_2 \cdot h=10\ 000$)

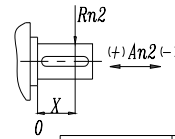
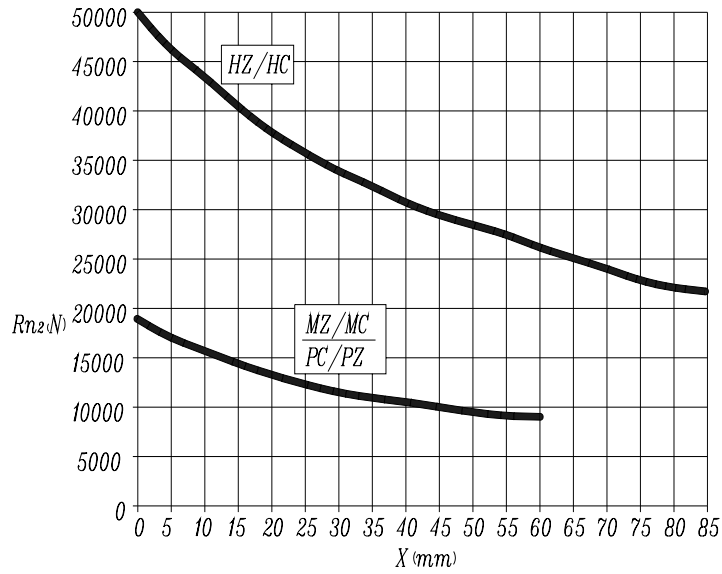

	$An_2(+)$	$An_2(-)$
MZ-MC-PC-PZ	20 000	15 000
HZ-HC	40 000	40 000

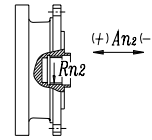

	R_{n2}	$An_2(+/-)$
FZ	8 000	8 000

Load corrective factor fh2 on shafts	fh2= $n_2 \cdot h$		10 000	25 000	50 000	100 000	500 000	1 000 000
	fh2	MZ-MC-PC-PZ-FZ	1	0.74	0.58	0.46	0.27	0.21
	HZ-HC	1	0.76	0.61	0.50	0.31	0.25	

Permissible radial loads on input shaft with Fh1 ($n_1 \cdot h=250\ 000$)

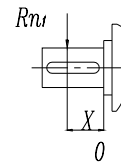
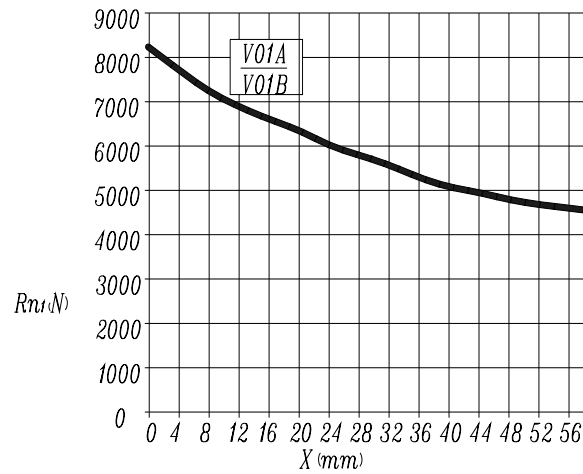

Load corrective factor fh1 on shafts	Fh1= $n_1 \cdot h$		250 000	500 000	1 000 000	2 00 000	5 000 000	10 000 000
	fh1		1	0.79	0.63	0.50	0.37	0.29

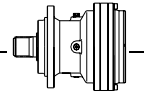

EP301L

M2'=2000N.m

	I 1:	Mn ₂ (N.m)						P ₁ (KW)	P _t (KW) (t _a =20°C) (n ₁ =1500)	n ₁ (min ⁻¹)	n _{1max} (min ⁻¹)	M _b (N.m)	Brake type
		n ₂ .h 10000	n ₂ .h 25000	n ₂ .h 50000	n ₂ .h 100000	n ₂ .h 500000	n ₂ .h 1000000						
L1	3.4	2 000	2 000	1 750	1 700	1 350	1 100	30	7.5	1 750	3 500	440	4L
	4.4	2 000	2 000	1 750	1 700	1 350	1 100	30	7.5	1 750	3 500	440	4L
	5.8	1 700	1 450	1 300	1 300	1 300	1 050	28	7.5	1 750	3 500	400	4K
	7.2	1 150	1 150	1 150	1 150	1 150	940	18	7.5	1 750	3 500	260	4F
L2	11.5	2 000	2 000	1 750	1 700	1 350	1 100	15	7.5	1 750	3 500	260	4F
	15	2 000	2 000	1 750	1 700	1 350	1 100	12	7.5	1 750	3 500	260	4F
	19.8	2 000	2 000	1 750	1 700	1 350	1 100	10	7.5	1 750	3 500	160	4D
	25.6	2 000	2 000	1 750	1 700	1 350	1 100	8.2	7.5	1 750	3 500	160	4D
	32	2 000	2 000	1 750	1 700	1 350	1 100	7.5	7.5	1 750	3 500	100	4B
	41.5	1 700	1 450	1 300	1 300	1 300	1 050	5.2	7.5	1 750	3 500	100	4B
	51.8	1 150	1 150	1 150	1 150	1 150	940	3.6	7.5	1 750	3 500	50	4A
	L3	38.8	2 000	2 000	1 750	1 700	1 350	1 100	6	7.5	1 750	3 500	100
50.9		2 000	2 000	1 750	1 700	1 350	1 100	4.9	7.5	1 750	3 500	50	4A
66.1		2 000	2 000	1 750	1 700	1 350	1 100	3.8	7.5	1 750	3 500	50	4A
87.8		2 000	2 000	1 750	1 700	1 350	1 100	3	7.5	1 750	3 500	50	4A
108		2 000	2 000	1 750	1 700	1 350	1 100	2.5	7.5	1 750	3 500	50	4A
114		2 000	2 000	1 750	1 700	1 350	1 100	2.4	7.5	1 750	3 500	50	4A
142		2 000	2 000	1 750	1 700	1 350	1 100	2	7.5	1 750	3 500	50	4A
185		2 000	2 000	1 750	1 700	1 350	1 100	1.6	7.5	1 750	3 500	50	4A
230		2 000	2 000	1 750	1 700	1 350	1 100	1.3	7.5	1 750	3 500	50	4A
299		1 700	1 450	1 300	1 300	1 300	1 050	1	7.5	1 750	3 500	50	4A
373	1 150	1 150	1 150	1 150	1 150	940	0.55	7.5	1 750	3 500	50	4A	
L4	297	2 000	2 000	1 750	1 700	1 350	1 100	1	6	1 750	3 500	50	4A
	386	2 000	2 000	1 750	1 700	1 350	1 100	0.8	6	1 750	3 500	50	4A
	476	2 000	2 000	1 750	1 700	1 350	1 100	0.68	6	1 750	3 500	50	4A
	501	2 000	2 000	1 750	1 700	1 350	1 100	0.65	6	1 750	3 500	50	4A
	625	2 000	2 000	1 750	1 700	1 350	1 100	0.55	6	1 750	3 500	50	4A
	650	2 000	2 000	1 750	1 700	1 350	1 100	0.53	6	1 750	3 500	50	4A
	780	2 000	2 000	1 750	1 700	1 350	1 100	0.45	6	1 750	3 500	50	4A
	853	2 000	2 000	1 750	1 700	1 350	1 100	0.42	6	1 750	3 500	50	4A
	1024	2 000	2 000	1 750	1 700	1 350	1 100	0.35	6	1 750	3 500	50	4A
	1108	1 700	1 450	1 300	1 300	1 300	1 050	0.25	6	1 750	3 500	50	4A
	1329	2 000	2 000	1 750	1 700	1 350	1 100	0.27	6	1 750	3 500	50	4A
	1383	1 700	1 450	1 300	1 300	1 300	1 050	0.2	6	1 750	3 500	50	4A
	1659	2 000	2 000	1 750	1 700	1 350	1 100	0.22	6	1 750	3 500	50	4A
	1725	1 700	1 450	1 300	1 300	1 300	1 050	0.17	6	1 750	3 500	50	4A
2153	1 700	1 450	1 300	1 300	1 300	1 050	0.14	6	1 750	3 500	50	4A	
2687	1 150	1 150	1 150	1 150	1 150	940	0.08	6	1 750	3 500	50	4A	

$$M_{2max}=1.2 \times Mn_2(n_2 \times h=10\ 000)$$

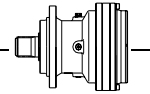

EP301R

M2'=2000N.m

	I 1:	Mn ₂ (N.m)						P ₁ (KW)	P _t (KW) (ta=20°C) (n ₁ =1500)	n ₁ (min ⁻¹)	n _{1max} (min ⁻¹)	M _b (N.m)	Brake type
		n ₂ .h 10000	n ₂ .h 25000	n ₂ .h 50000	n ₂ .h 100000	n ₂ .h 500000	n ₂ .h 1000000						
R2	6.9	1 200	1 200	1 200	1 200	1 100	930	15	12	1 750	3 500	260	4F
	9.1	1 450	1 450	1 450	1 450	1 250	1 050	15	12	1 750	3 500	260	4F
	11.8	1 700	1 450	1 300	1 300	1 300	1 050	14	12	1 750	3 500	260	4F
	14.8	1 150	1 150	1 150	1 150	1 150	940	11	12	1 750	3 500	160	4D
R3	23.5	2 000	2 000	1 750	1 700	1 350	1 100	8	12	1 750	3 500	160	4D
	30.8	2 000	2 000	1 750	1 700	1 350	1 100	7.7	12	1 750	3 500	100	4B
	40.5	2 000	2 000	1 750	1 700	1 350	1 100	6.3	12	1 750	3 500	100	4B
	52.6	2 000	2 000	1 750	1 700	1 350	1 100	5	12	1 750	3 500	100	4B
	65.6	2 000	2 000	1 750	1 700	1 350	1 100	4.1	12	1 750	3 500	50	4A
	85.2	1 700	1 450	1 300	1 300	1 300	1 050	2.7	12	1 750	3 500	50	4A
	106	1 150	1 150	1 150	1 150	1 150	940	1.9	12	1 750	3 500	50	4A
R4	79.5	2 000	2 000	1 750	1 700	1 350	1 100	3.5	10	1 750	3 500	50	4A
	104	2 000	2 000	1 750	1 700	1 350	1 100	2.7	10	1 750	3 500	50	4A
	136	2 000	2 000	1 750	1 700	1 350	1 100	2.2	10	1 750	3 500	50	4A
	180	2 000	2 000	1 750	1 700	1 350	1 100	1.7	10	1 750	3 500	50	4A
	222	2 000	2 000	1 750	1 700	1 350	1 100	1.4	10	1 750	3 500	50	4A
	234	2 000	2 000	1 750	1 700	1 350	1 100	1.3	10	1 750	3 500	50	4A
	292	2 000	2 000	1 750	1 700	1 350	1 100	1.1	10	1 750	3 500	50	4A
	378	2 000	2 000	1 750	1 700	1 350	1 100	0.85	10	1 750	3 500	50	4A
	472	2 000	2 000	1 750	1 700	1 350	1 100	0.67	10	1 750	3 500	50	4A
	613	1 700	1 450	1 300	1 300	1 300	1 050	0.43	10	1 750	3 500	50	4A
765	1 150	1 150	1 150	1 150	1 150	940	0.27	10	1 750	3 500	50	4A	

$$M_{2max}=1.2 \times Mn_2(n_2 \times h=10\ 000)$$

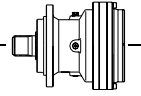

EP301L

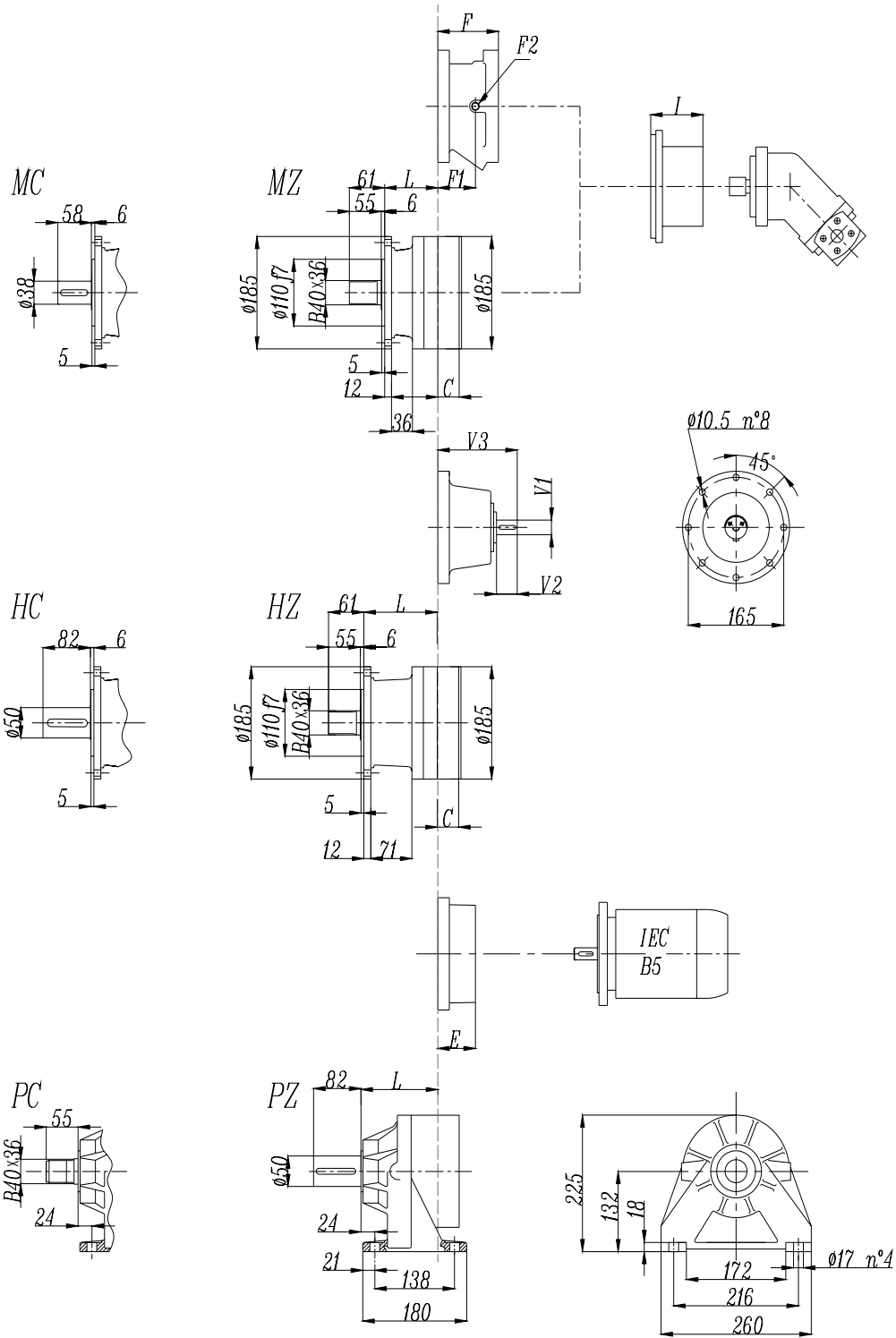

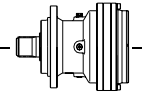

EP301L

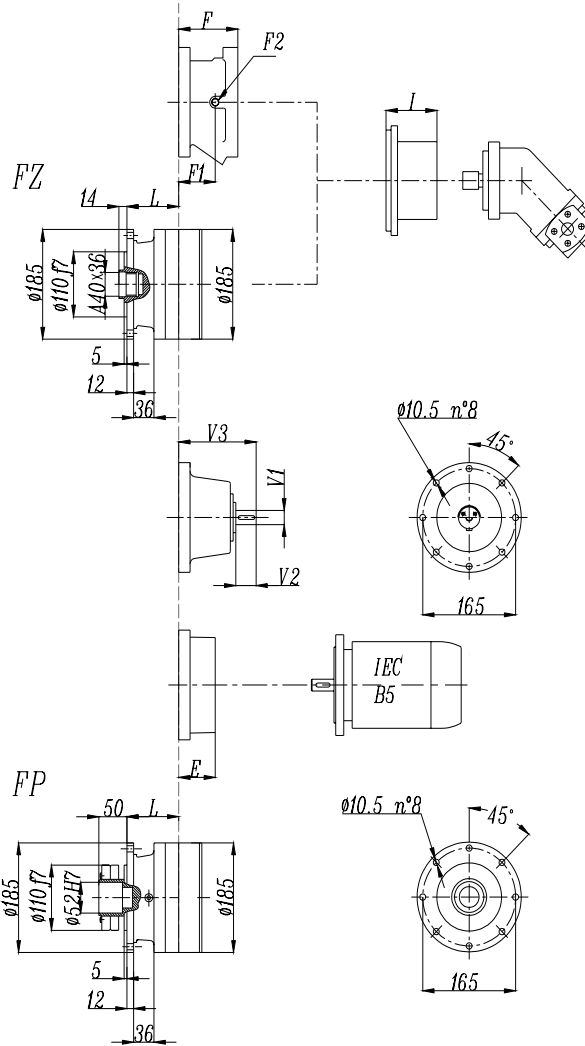

FP version
 Max. transmissible
 2400 N.m

	L				Ref. weight (without input) (Kg)				C	I	Brake				Ref. Weight 15 Kg
	MZ MC	FZ FP	HZ HC	PC PZ	MZ MC	FZ FP	HZ HC	PC PZ			F	F1	F2	Type	
301L1	92	92	127	133	21	19	23	26	37	According to hydraulic motor	105	65	1/4 G	4	
301L2	145	145	180	186	25	23	27	30	37		105	65	1/4 G	4	
301L3	198	198	233	239	29	27	31	34	37		105	65	1/4 G	4	
301L4	251	251	251	292	33	31	35	38	37		105	65	1/4 G	4	

	E (IEC motor input)							
		IEC71	IEC80	IEC90	IEC100	IEC112	IEC132	IEC160
301L1		65	84	84	94	94	114	144
301L2		65	84	84	94	94	114	144
301L3		65	84	84	94	94	114	144
301L4		65	84	84	94	94	114	144

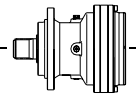

EP301R

